

# INNENSTUCK

# STAFF DÉCOR

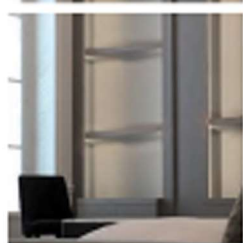

# SOMMAIRE

|  |            |
|--|------------|
| <b>NOUVEAUTÉS</b>                      | <b>6</b>   |
| <b>LE PLAFOND</b>                      | <b>12</b>  |
| LES CORNICHES                          | 16         |
| LES MOULURES                           | 38         |
| LES ANGLES & DOUCINES DE MOULURES      | 44         |
| LES ROSACES & CAISSONS DE PLAFOND      | 48         |
| LA COLLECTION ORIENTALE                | 66         |
| <b>LES MURS</b>                        | <b>70</b>  |
| LES PANNEAUX 3D & PAREMENTS            | 74         |
| L'HABILLAGE MURAL PAR LAMBRISSAGE      | 96         |
| LES HABILLAGES DE PORTE                | 104        |
| LES FRONTONS                           | 106        |
| LES COLONNES & LES PILASTRES           | 108        |
| <b>LES AGENCEMENTS &amp; MOBILIERS</b> | <b>118</b> |
| LES MODULOSTAFF & NICHES               | 122        |
| LES TÊTES DE LIT                       | 130        |
| LES MEUBLES EN STAFF                   | 132        |
| LES PASSAGES & MEUBLES DE PASSAGE      | 138        |
| LES CACHE-RADIATEURS                   | 146        |
| <b>LES CHEMINÉES</b>                   | <b>150</b> |
| <b>LES LUMINAIRES</b>                  | <b>154</b> |
| <b>LES PRODUITS TECHNIQUES</b>         | <b>160</b> |



D880B

> Largeur de l'ornement :  
104 cm

© Anthony Gire

## Nouveau cartouche pour corniche D880 !

En complément de notre écoinçon D880A et de la corniche D880, nous vous proposons de découvrir le cartouche finement ornementé D880B.

Idéal pour rompre le rythme de votre corniche et équilibrer votre espace !

## Personnalisez vos appliques !

Faites y graver vos initiales,  
des motifs ornementaux ou encore des pictogrammes de votre choix !  
Adaptez-les à votre personnalité ou encore à votre marque !

Série d'appliques 110

> 46 x 46 cm



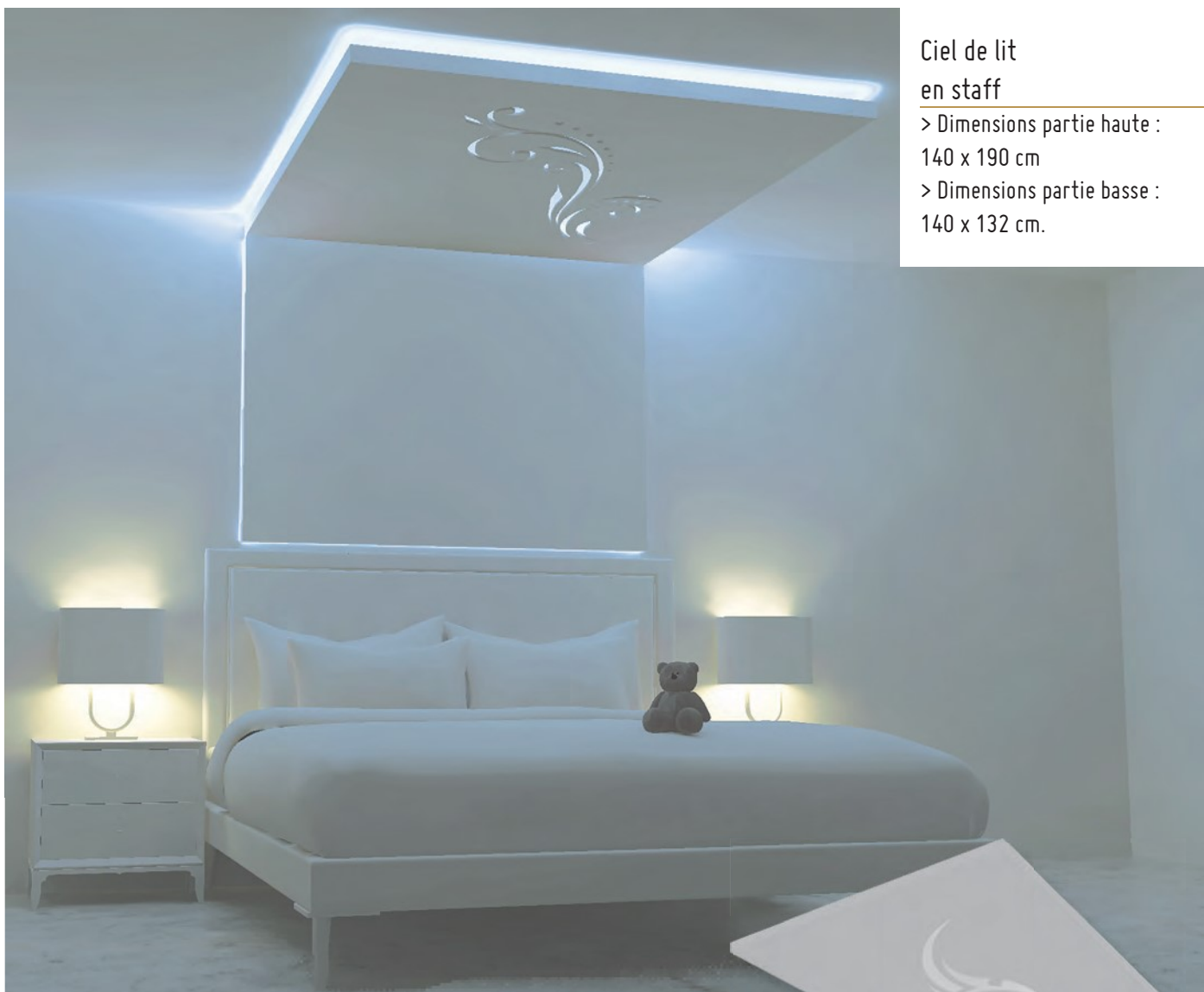

### Ciel de lit en staff

> Dimensions partie haute :

140 x 190 cm

> Dimensions partie basse :

140 x 132 cm.

*Découvrez une autre façon de styliser votre chambre à coucher !*

## Ciel de lit ou baldaquin en staff

Produit idéal pour surplomber une tête de lit préalablement installée ou encore s'y subtiliser ! N'hésitez pas à les détourner et à les décliner sans modération dans toutes les pièces de la maison !



### AUTRES MOTIFS

Vous pouvez personnaliser vos baldaquins. D'autres modèles existent au sein de nos collections, pensez à demander avis à votre conseiller Staff Décor.



CL36  
Prisme  
122 x 122 cm  
Conditionnement : à l'unité  
Épaisseur : 3,2 cm  
Surface : 1,49 m<sup>2</sup> / plaque  
Poids unitaire : 18 kg

*Désormais dans  
la gamme  
standard !*

Réf CL37  
Le Flore  
2,60 x 1,23 m  
Conditionnement : à l'unité



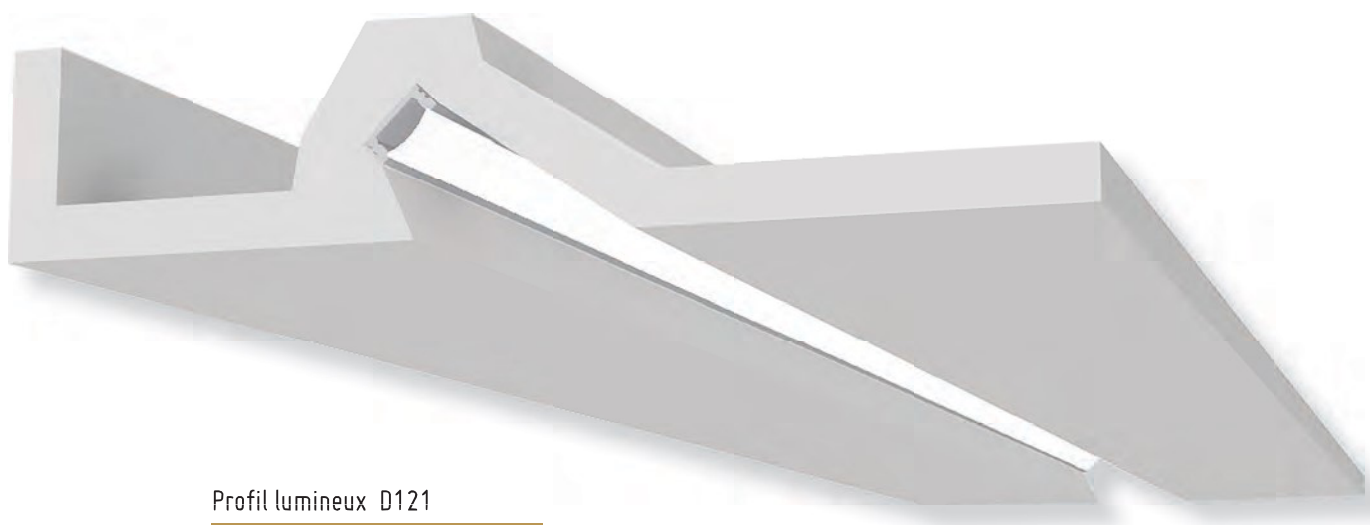

**Profil lumineux D121**  
en 2 ml

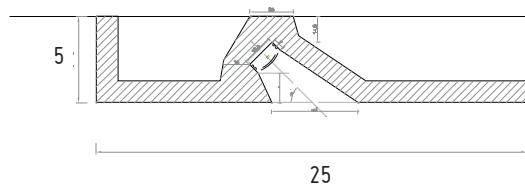

**Bandeau lumineux BL180**  
en 2 ml  
27,1 x 6,6 cm

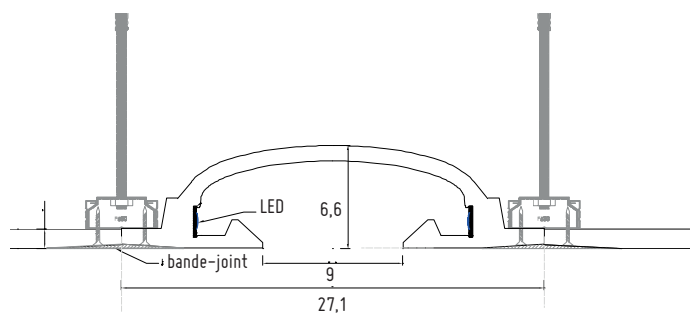

**Profil D118**  
en 2 ml  
15 + 10 + 10 cm

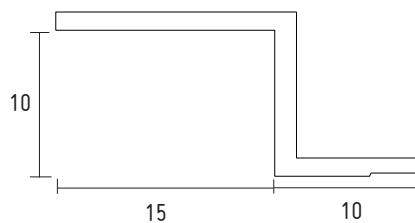

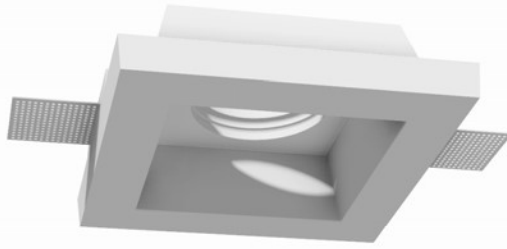

**ENC31**

12 x 12 x 3,8 cm

Pour spot Ø 5,1 cm

Finition : plâtre brut

Poids : 0,32 kg

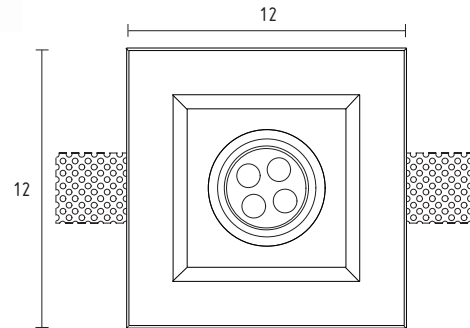

**ENC32**

12 x 12 x 3,8 cm

Pour spot Ø 5,1 cm

Finition : plâtre brut

Poids : 0,32 kg

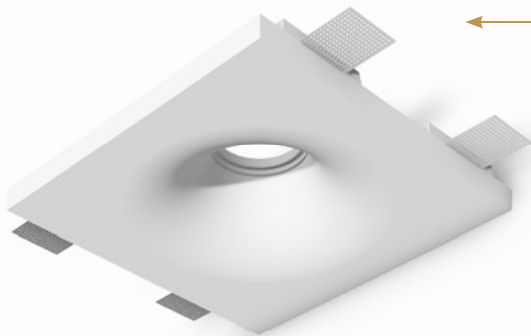
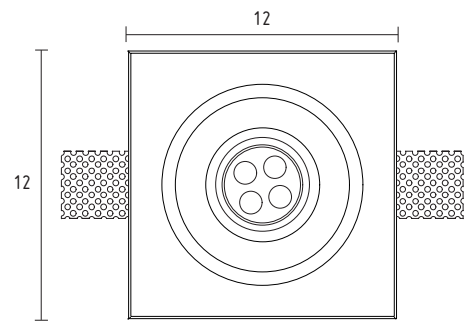
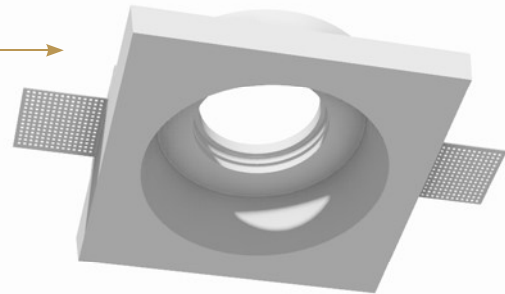

**ENC35**

18 x 18 x 5 cm

Pour spot Ø 5,1 cm

Finition : plâtre brut

Poids : 0,58 kg

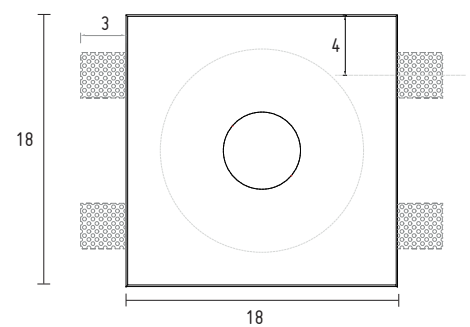



### COUPOLE LUMINEUSE ENC41

76,4 x 76,4 x 17,5 cm

Attention : Il faudra impérativement prévoir un plénum de 19 cm pour l'ensemble de votre installation.

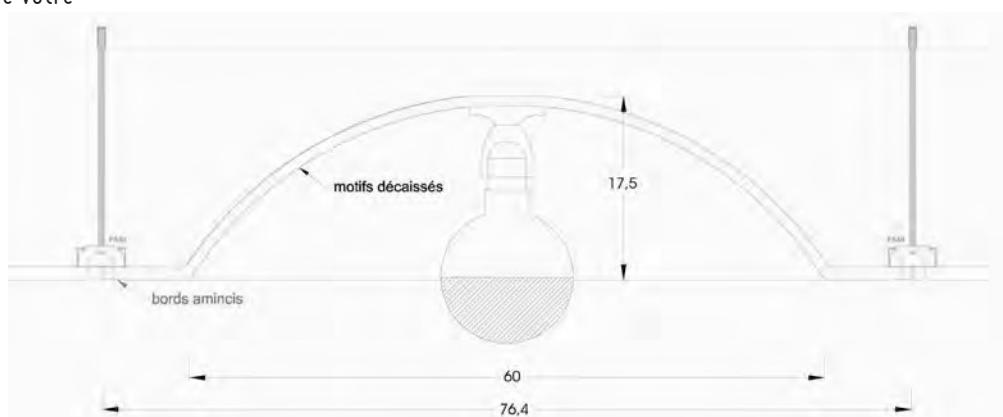



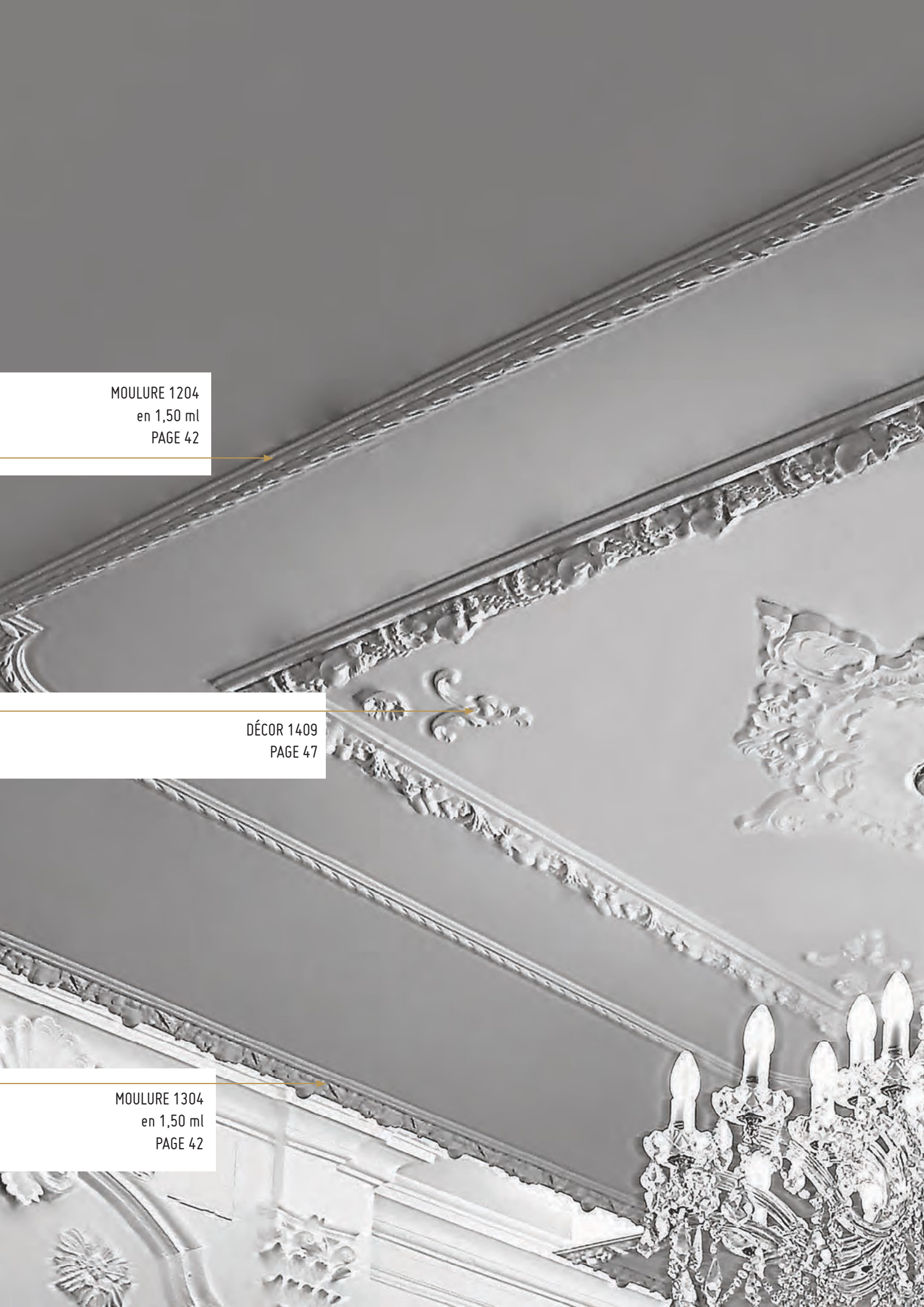

MOULURE 1204  
en 1,50 ml  
PAGE 42

This image shows a detailed view of a ceiling with multiple layers of decorative moldings. The moldings are intricate, featuring floral and scrollwork patterns. A large, ornate chandelier with multiple lit candles is visible in the lower right corner. The overall aesthetic is classic and elegant.

DÉCOR 1409  
PAGE 47

MOULURE 1304  
en 1,50 ml  
PAGE 42



ANGLE DE MOULURE 1204H  
PAGE 47

MOULURE 1303  
en 1,50 ml  
PAGE 42

ROSACE M071  
PAGE 59

# LE PLAFOND



|  |                                |           |
|--|--------------------------------|-----------|
|  | <b>LES CORNICHES</b>           | <b>16</b> |
|  | CORNICHES CONTEMPORAINES       | 18        |
|  | CORNICHES À ÉCLAIRAGE INDIRECT | 24        |
|  | CORNICHES CLASSIQUES           | 30        |
|  | CORNICHES ORNEMENTÉES          | 34        |

|   |                      |           |
|---|----------------------|-----------|
|  | <b>LES MOULURES</b>  | <b>38</b> |
|   | MOULURES LISSES      | 40        |
|   | MOULURES ORNEMENTÉES | 42        |

|  |  |           |
|--|--|-----------|
|  | <b>LES ANGLES &amp; DOUCINES DE MOULURES</b> | <b>44</b> |
|  | MOULURES & ANGLES DE MOULURES                | 46        |
|  | DOUCINES                                     | 47        |
|  | ANGELOTS                                     | 47        |

|   |  |           |
|---|--|-----------|
|  | <b>LES ROSACES &amp; LES CAISSONS DE PLAFOND</b> | <b>48</b> |
|   | ROSETTES   | 50        |
|   | ROSACES ORNEMENTÉES                              | 51        |
|   | ROSACES LISSES                                   | 63        |
|   | CAISSONS DE PLAFOND                              | 64        |

|   |                                |           |
|---|--------------------------------|-----------|
|  | <b>LA COLLECTION ORIENTALE</b> | <b>66</b> |
|   | MOULURES & FRISES              | 68        |
|   | ABAT-JOUR                      | 68        |
|   | ROSACES                        | 69        |
|   | FRONTONS & CHAPITEAUX          | 69        |



CORNICHE D898  
en 2 ml  
PAGE 34

# LES CORNICHES

CORNICHE D575

en 2 ml

PAGE 19

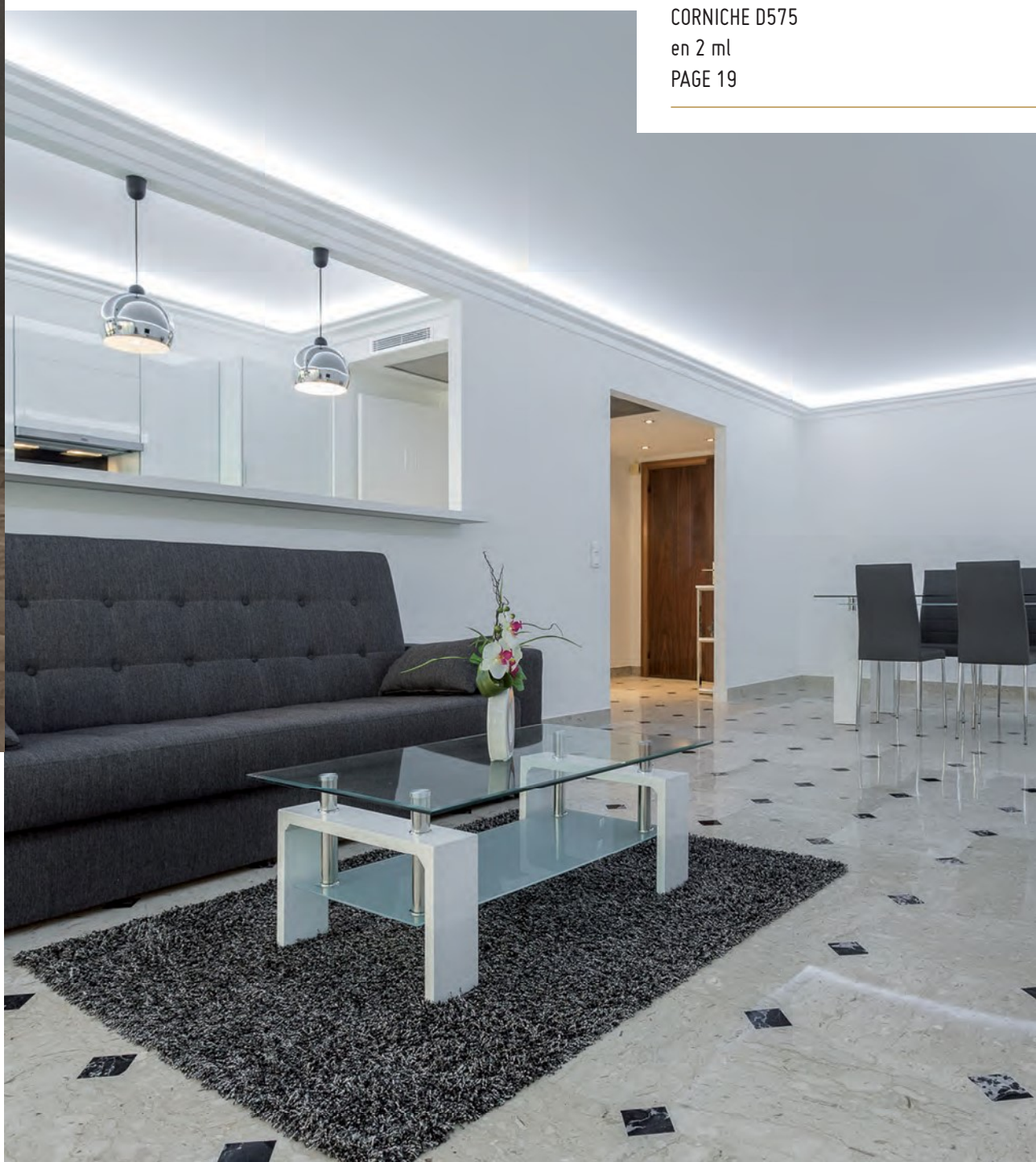

CORNICHES CONTEMPORAINES

D568 (en 2 ml)

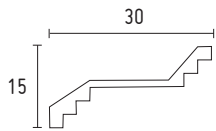

D891 (en 2 ml)

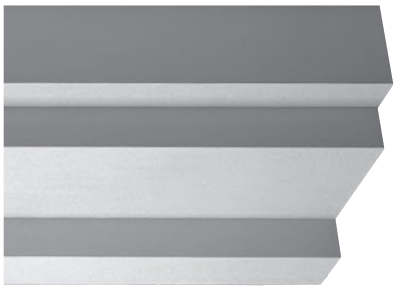
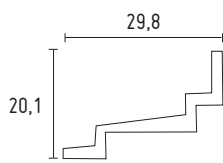

D564 (en 2 ml)

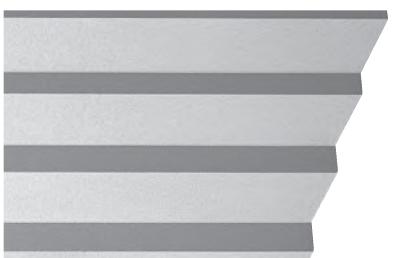
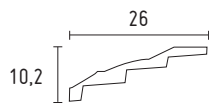

D567 (en 2 ml)



CORNICHE D565  
en 2 ml page 19

D577 (en 2 ml)

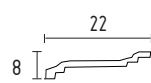

D579 (en 2 ml)

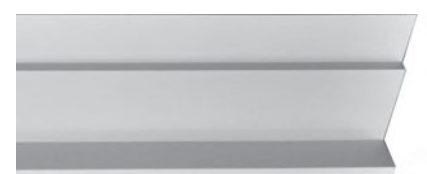

D901 (en 2 ml)

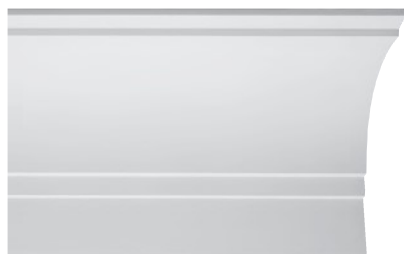
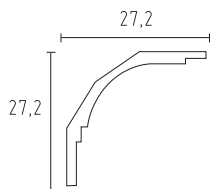

D576 (en 2 ml)



D563 (en 2 ml)

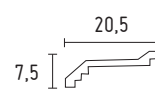

D565 (en 2 ml)



D580 (en 2 ml)

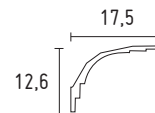

D720 (en 2 ml)

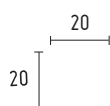

D562 (en 2 ml)



D575 (en 2 ml)



D718 (en 2 ml)

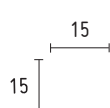

D578 (en 2 ml)



D620 (en 2 ml)

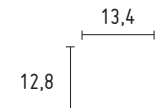

D631 (en 2 ml)

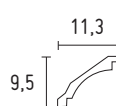

D621 (en 2 ml)



D705 (en 2 ml)

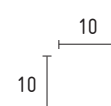

D706 (en 2 ml)

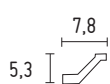

D561 (en 2 ml)



D555 (en 1,50 ml)







POSÉE EN PÉRIPHÉRIE DE LA PIÈCE,  
LA DEMI-VAGUE SERPENTE LE LONG DES  
PLAFONDS POUR EN ADOUCIR LES ANGLES.

## VAGUE DE SÉPARATION avec corniche D577 intégrée

Ce décor de plafond préfabriqué monobloc en forme permet de créer au sein d'une grande pièce deux espaces distincts. Par exemple, il assurera la séparation entre le coin séjour et le coin salon.

- > Largeur avec corniche : 104 cm
  - > Largeur de la plage : 60 cm
  - > Longueur sur mesure (possibilité jusqu'à 6 mètres, livrés en plusieurs éléments si nécessaire en fonction des contraintes d'accessibilité)
  - > La retombée de 8 cm permet de repenser l'éclairage de la pièce par l'installation de spots.
- Il est préférable de réaliser les trous de réservation pour les spots lors de la fabrication de l'élément.



Face intérieure du moulage faisant apparaître les renforts métalliques de type F530 qui pourront être utilisés pour la fixation au plafond de la vague.

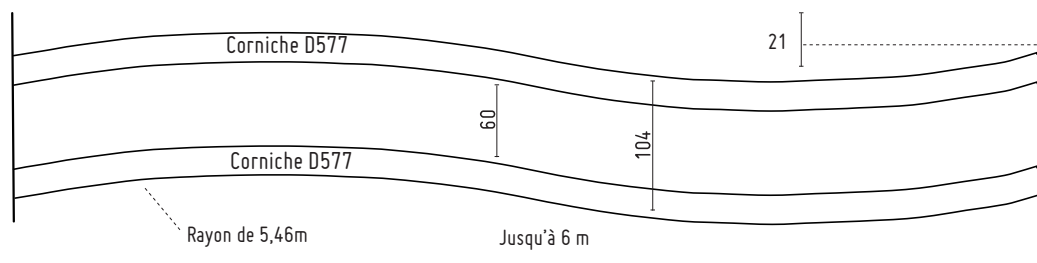
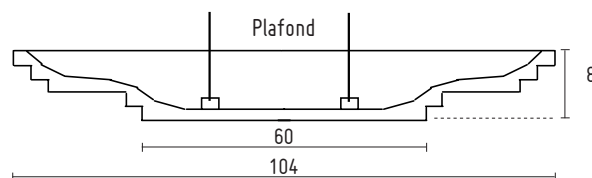

## CORNICHE EN VAGUE

Ce décor de plafond associe sur un même moulage une plage horizontale d'une largeur variable jusqu'à 67 cm pour la référence SV577 et 83 cm pour la SV748 et une corniche dont les ondulations régulières forment des vagues qui se propagent le long des murs.

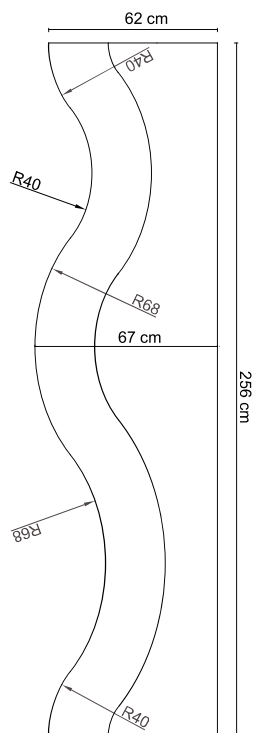

POSÉE DIRECTEMENT AU PLAFOND, LA VAGUE RÉF. SV577 PERMET D'INTÉGRER UN ÉCLAIRAGE PAR SPOTS.

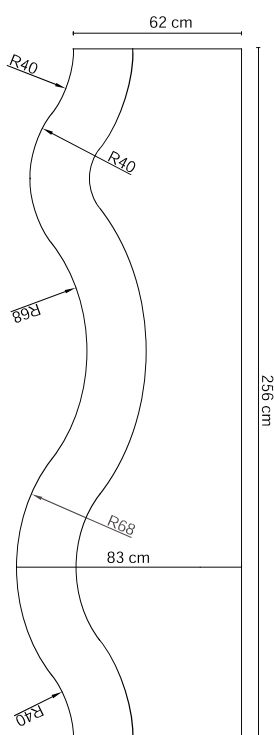

POSÉE À 10 CM ENVIRON DU PLAFOND, LA CORNICHE EN VAGUE RÉF. SV748 CONSTITUE ÉGALEMENT LE SUPPORT ORIGINAL D'UN ÉCLAIRAGE INDIRECT.

## LA CORNICHE S908

Le profil de cette corniche peut être fabriqué en un seul élément présentant une avancée sur le plafond de 90 cm et une longueur pouvant atteindre 290 cm. La réalisation de ce décor de plafond en staff traditionnel aurait conduit à poser, assembler et jointoyer sur le chantier deux corniches distinctes reliées entre elles par une plage horizontale de 51 cm en staff ou en plaque de plâtre. Ce profil S908 est fixé mécaniquement par vissage sur ossatures fixées sur le mur et sur le plafond, ce qui simplifie la mise en œuvre et en réduit substantiellement les délais d'exécution.

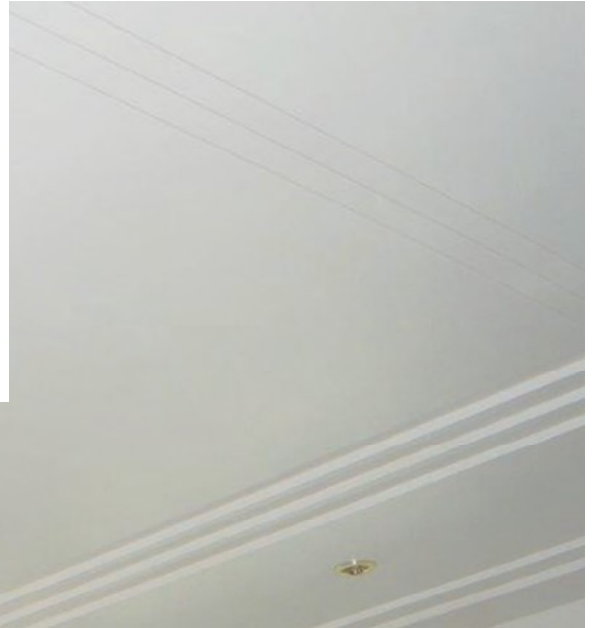

Pour composer ce plafond, il vous faudra intégrer deux éléments distincts :

> L'élément d'angle Réf S908A

> L'élément de côté Réf S908

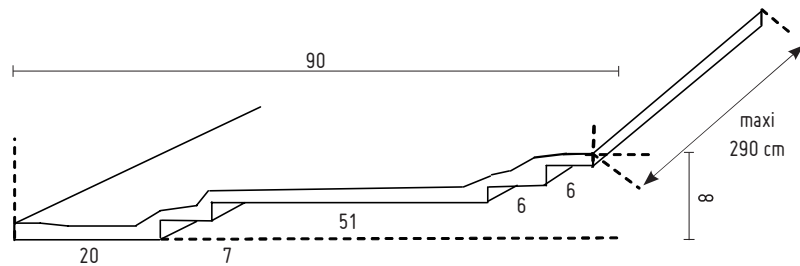
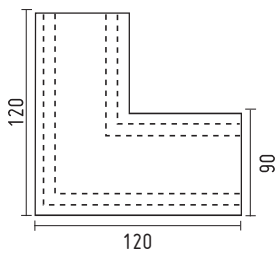

Les éléments de côté sont fabriqués selon un plan de calepinage établi sur la base des dimensions du plafond.  
Le poids de cet ensemble sera d'environ 9 à 10 kg/m<sup>2</sup>.

### LES AVANTAGES

- > Installation très rapide, les éléments s'emboîtent les uns dans les autres.
- > Conservation de la hauteur sous-plafond.
- > Possibilité d'installer un éclairage direct ou indirect.
- > Les moulages sont préparés pour faciliter leur montage.

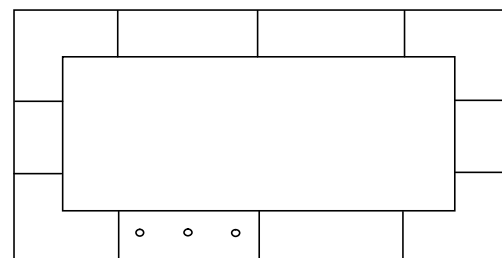

### Mise en œuvre simple par vissage

> Montage classique avec spot

> Montage en éclairage indirect (équerre en supplément)

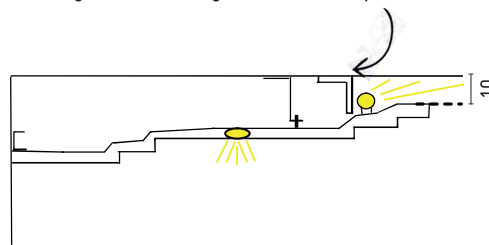
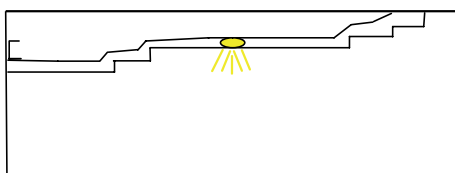

## DÉCORS DE PLAFOND EN «U»

Ce décor de plafond tout en sobriété est composé d'éléments en forme de «U» et de 2,50 ml de long. Disponible en 2 hauteurs (7 cm ou 10 cm) selon l'encombrement des luminaires à intégrer dans la partie centrale surépaissie. Il est mis en oeuvre par simple vissage sur tasseaux. Ces décors sont réalisés en Stratistaff (staff aminci). Vous pouvez retrouver l'ensemble de nos profils "U" en staff traditionnel à la page 160.

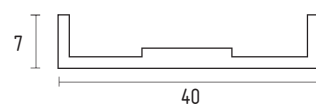

Réf. US0740 (en 2,50 ml)

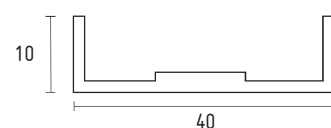

Réf. US1040 (en 2,50 ml)

Montée en soffite, cet élément décoratif redessine les espaces et permet l'installation de nouveaux éclairages tout en dissimulant le passage des gaines électriques.

## JOINTS CREUX

Les joints creux sont fournis en longueur de 2 ml.

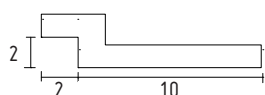

JC22.10

Joint creux 2 + 2 + 10 cm, ep. 1,5 cm

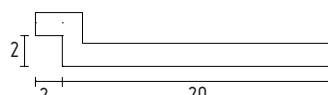

JC22.20

Joint creux 2 + 2 + 20 cm, ep. 1,5 cm

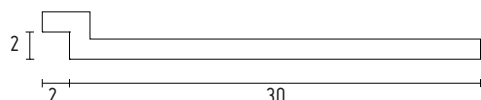

JC22.30

Joint creux 2 + 2 + 30 cm, ep. 1,5 cm

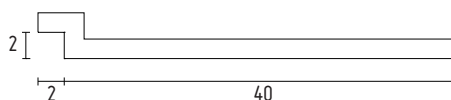

JC22.40

Joint creux 2 + 2 + 40 cm, ep. 1,5 cm

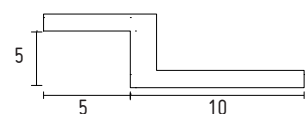

JC55.10

Joint creux 5 + 5 + 10 cm, ep. 1,5 cm

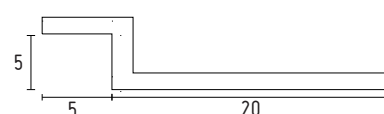

JC55.20

Joint creux 5 + 5 + 20 cm, ep. 1,5 cm



# CORNICHES À ÉCLAIRAGE INDIRECT

D710 (en 2 ml)



D748 (en 2 ml)

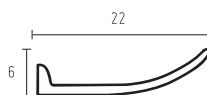

D749 (en 2 ml)

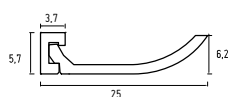

D708 (en 2 ml)

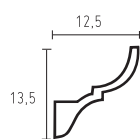

D709 (en 2 ml)

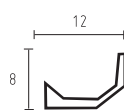

CORNICHE D748  
en 2ml

## SCHEMA DE PRINCIPE D709

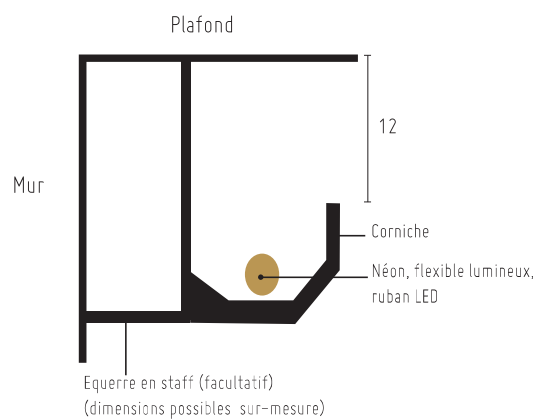

D101 (en 2 ml)

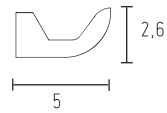

D102 (en 2 ml)

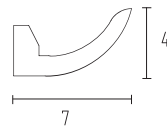

D103 (en 2 ml)

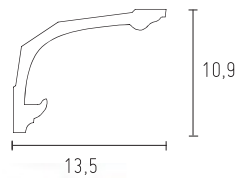

D104 (en 2 ml)

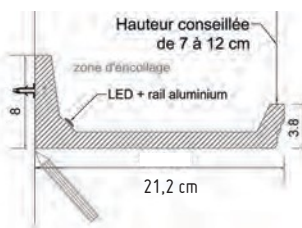

D105 A & B (en 2 ml)

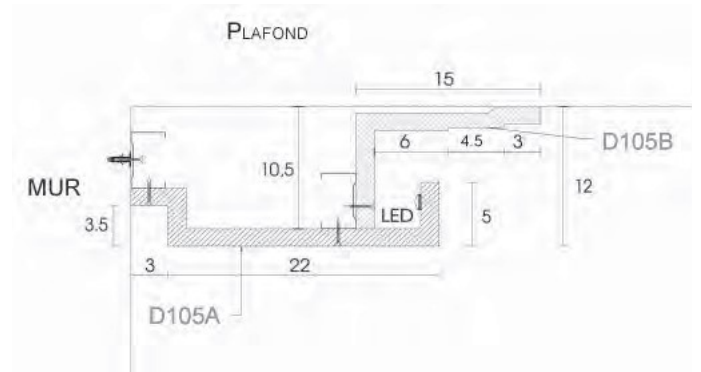

CORNICHE D105A en 2ml

# CORNICHES À ÉCLAIRAGE INDIRECT

D105A (en 2 ml)

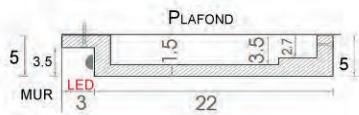

D106 (en 2 ml)

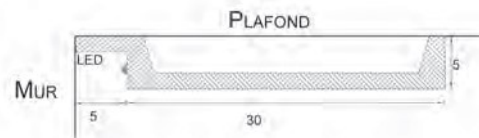

D108 (en 2 ml)

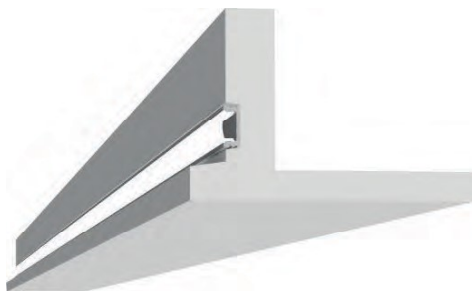
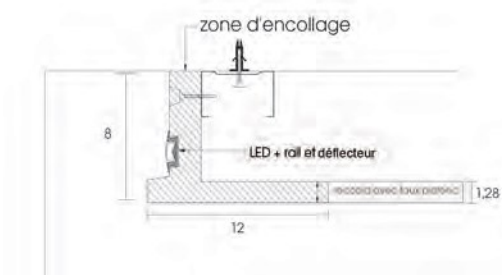

D107 (en 2 ml)

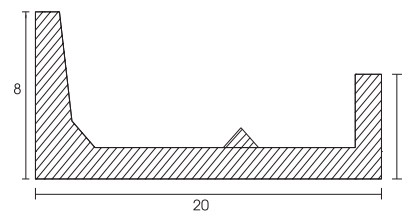

D110 (en 2 ml)

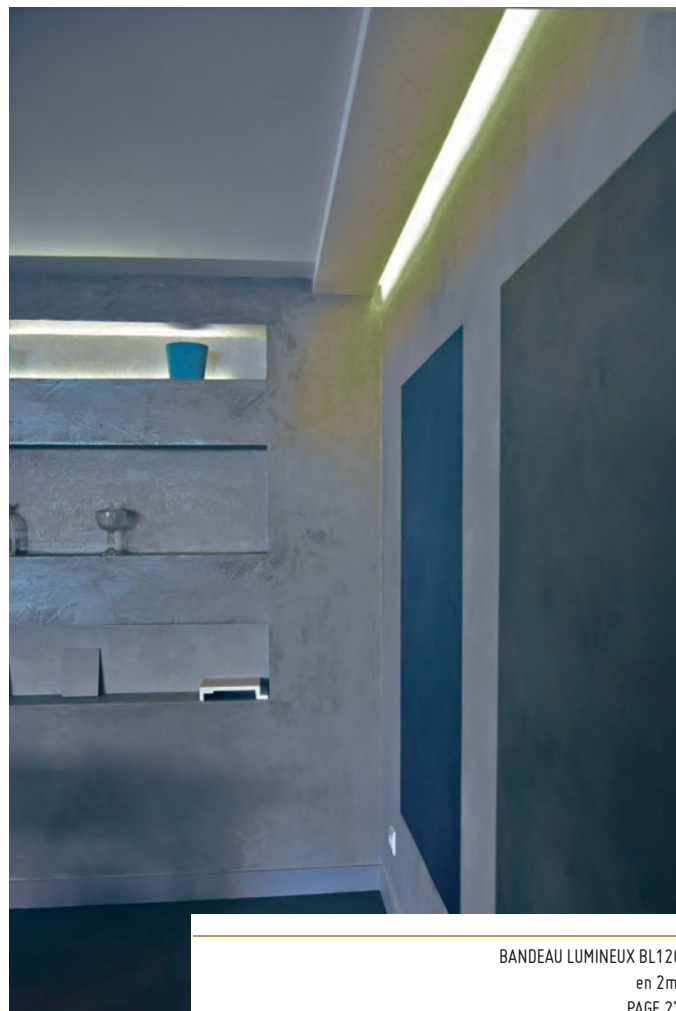
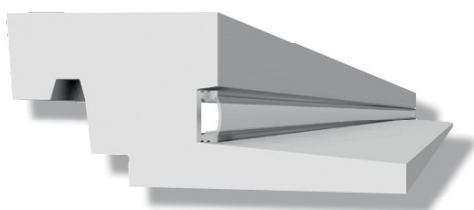
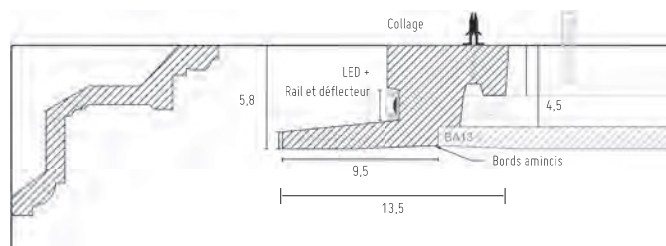

BANDEAU LUMINEUX BL120  
en 2ml  
PAGE 27

## PROFILS LUMINEUX COMPOSABLES

EMB95 (en 2 ml) > 9,7 x 4 cm  
 EBL0430 (en 2 ml) > 30 x 4 cm

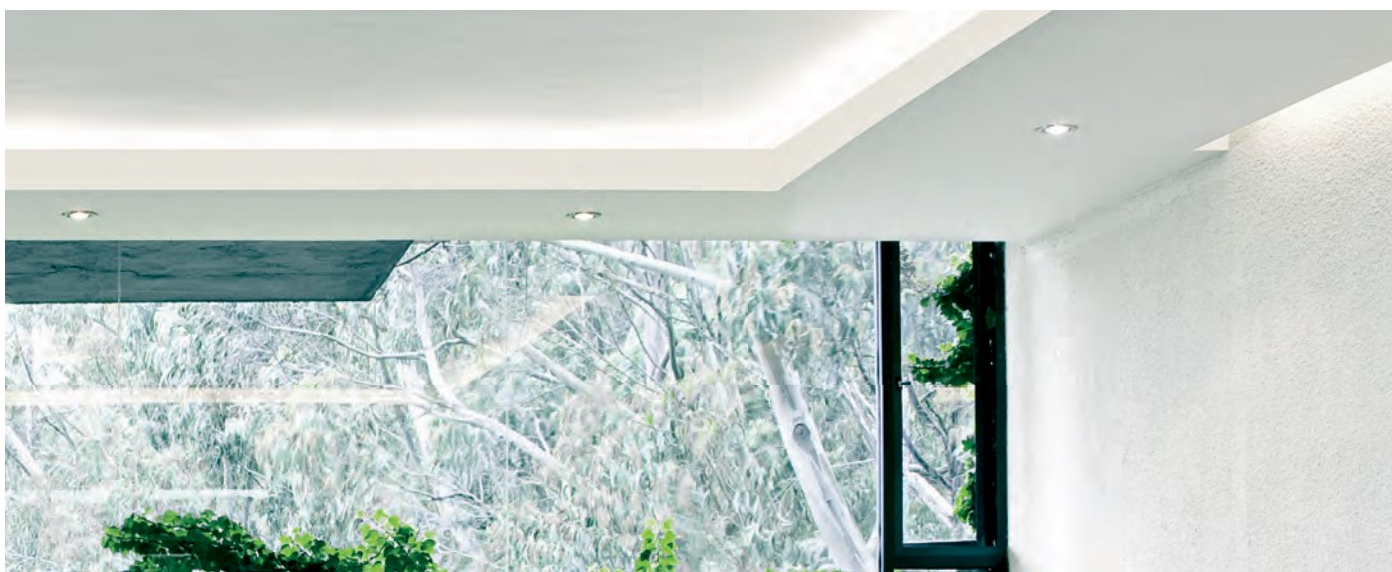
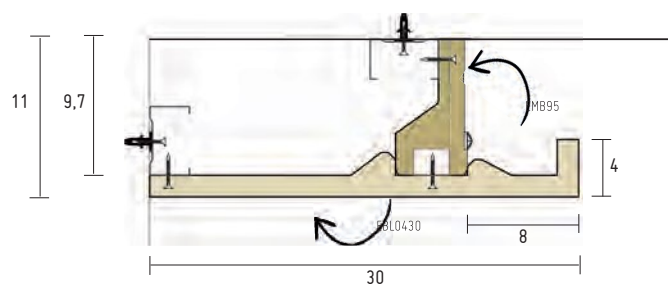
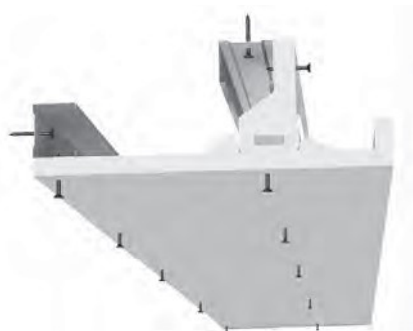

## PROFILS LUMINEUX COMPOSABLES

Les bandeaux lumineux sont des profils pouvant se poser en relief ou à fleur de vos murs et plafonds.

BL120 (en 2 ml)

Profil à associer à un rail en aluminium avec déflecteur en polycarbonate et un flexible LED.

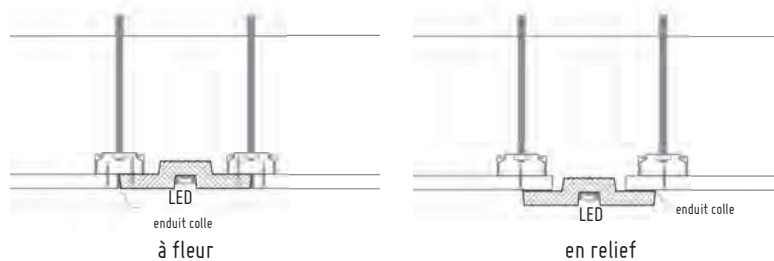
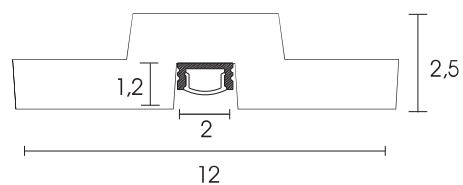



# CORNICHES À ÉCLAIRAGE INDIRECT

BL130 (en 2,6 ml)  
7 x 5 cm

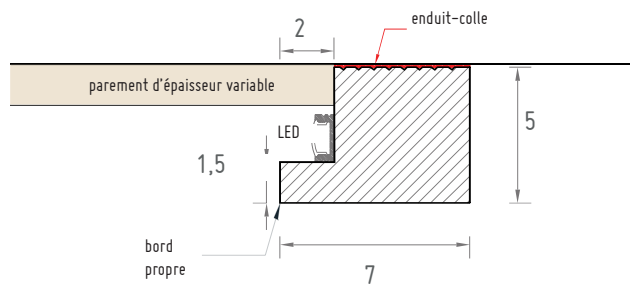

BL131 (en 2,5 ml)  
10 x 7 cm

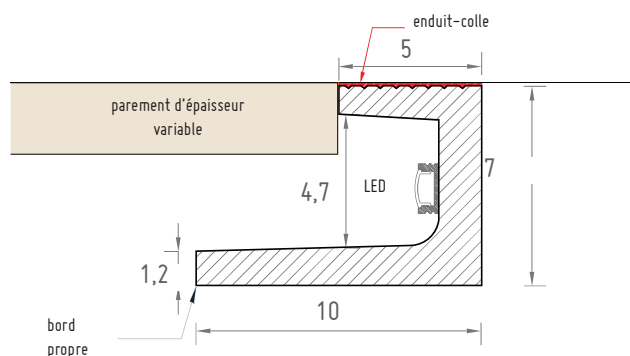
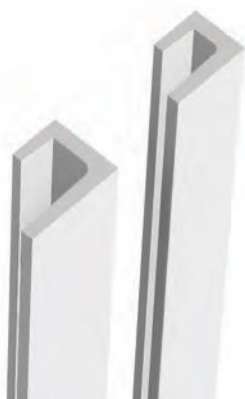

BL132 (en 2,5 ml)  
8 x 5,5 cm

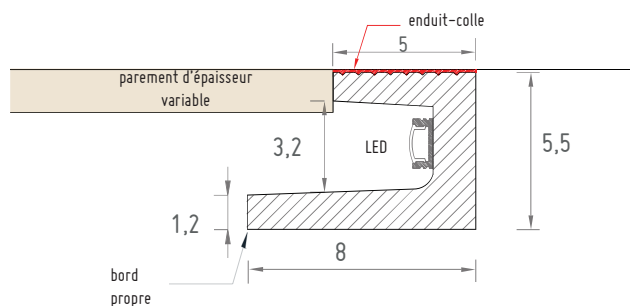
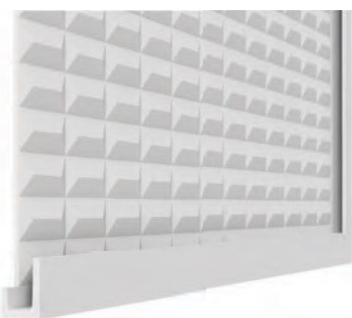

BL140 (en 2,8 ml)  
8 x 4 cm

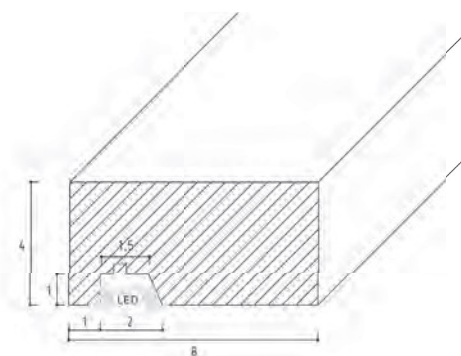

BL160 (en 2 ml)  
19 x 6 cm

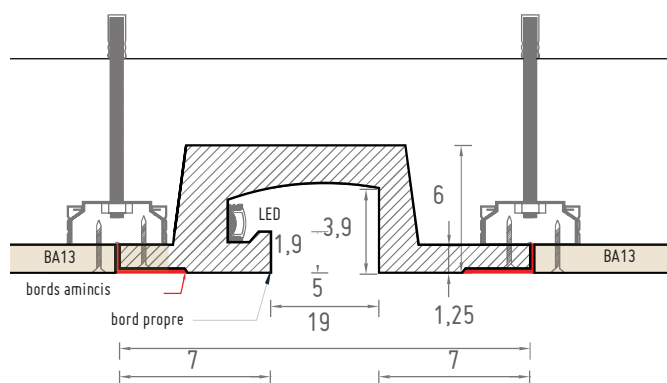
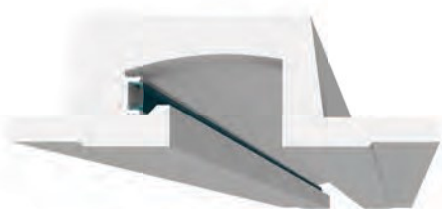

BL170 (en 2 ml)  
19,5 x 4,7 cm

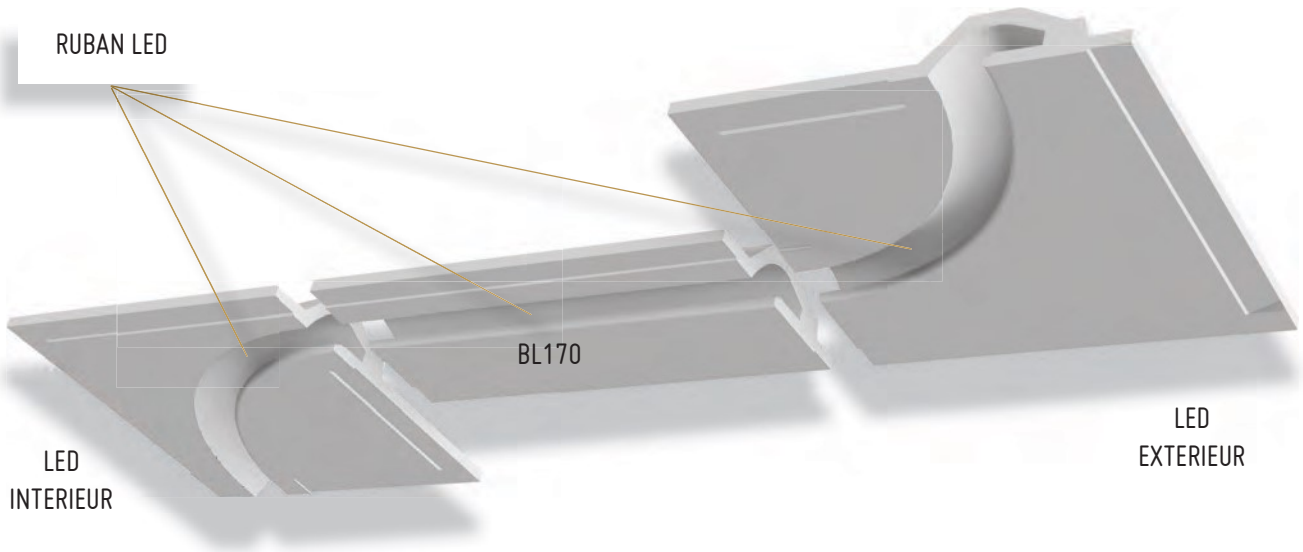
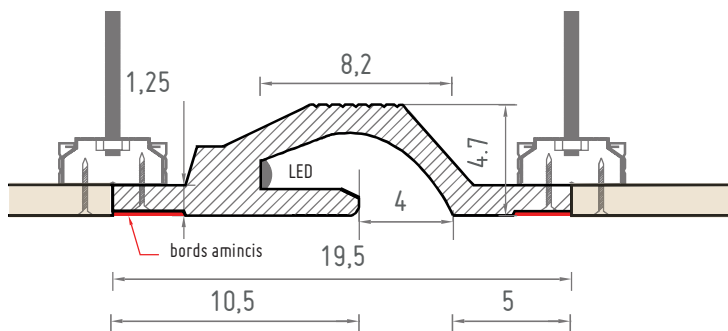

BL170  
en 2 ml

**BL170R25I**

Gorge lumineuse cintrée de  
25 cm de rayon Led Intérieur  
34 x 34 cm

**BL170R25E**

Gorge lumineuse cintrée de  
25 cm de rayon Led Extérieur  
35,5 x 35,5 cm

**BL170R50I**

Gorge lumineuse cintrée de  
50 cm de rayon Led Intérieur  
59 x 59 cm

**BL170R50E**

Gorge lumineuse cintrée de  
50 cm de rayon Led Extérieur  
60,5 x 60,5 cm

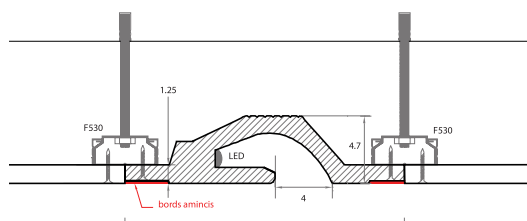

LED INTERIEUR

LED EXTERIEUR

D892 (en 2 ml)

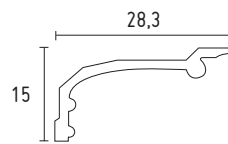

D560 (en 2 ml)

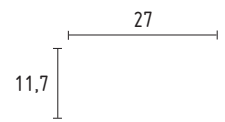

D900 (en 2 ml)

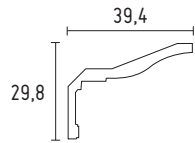

D802 (en 2 ml)

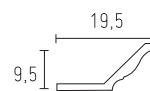

D601 (en 2 ml)

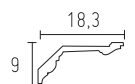

### Le saviez-vous ?

Toutes nos corniches contemporaines, classiques et ornementées peuvent être cintrées !

Confiez-nous vos plans et gabarits. Renseignez-vous auprès de votre agence Staff Décor et réalisons vos projets !

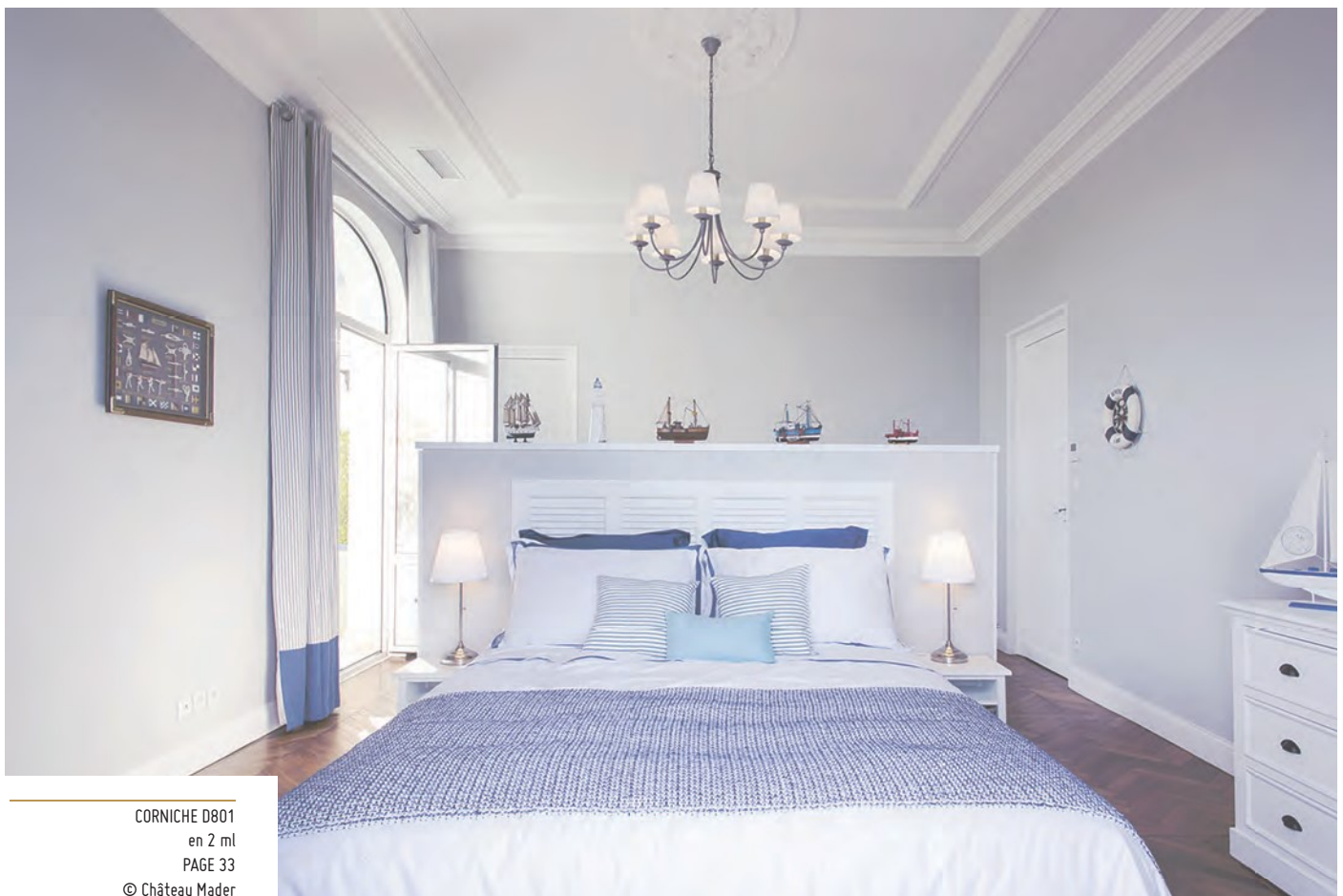

CORNICHE D801  
en 2 ml  
PAGE 33  
© Château Mader

D605 (en 2 ml)

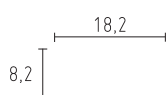

D609 (en 2 ml)

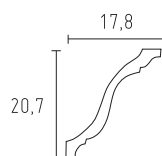

D626 (en 1,75 ml)

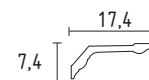

D574 (en 2 ml)

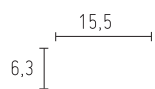

D608 (en 2 ml)

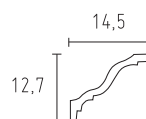

D830 (en 2 ml)

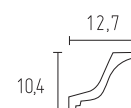

D611 (en 1,75 ml)

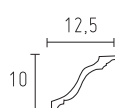

D604 (en 2 ml)

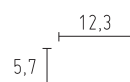

D545 (en 1,75 ml)

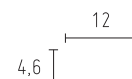

D612 (en 2 ml)



D614 (en 1,75 ml)

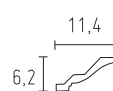

D625 (en 1,75 ml)

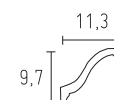

D610 (en 1,75 ml)

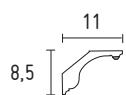

D707 (en 2 ml)

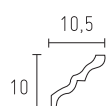

D630 (en 1,75 ml)



D704 (en 2 ml)



D520 (en 1,75 ml)



D703 (en 1,75 ml)



# CORNICHES CLASSIQUES

## ÉCOINÇON DE CORNICHE D880A

Angle : 80 x 80 cm

Hauteur : 18 cm

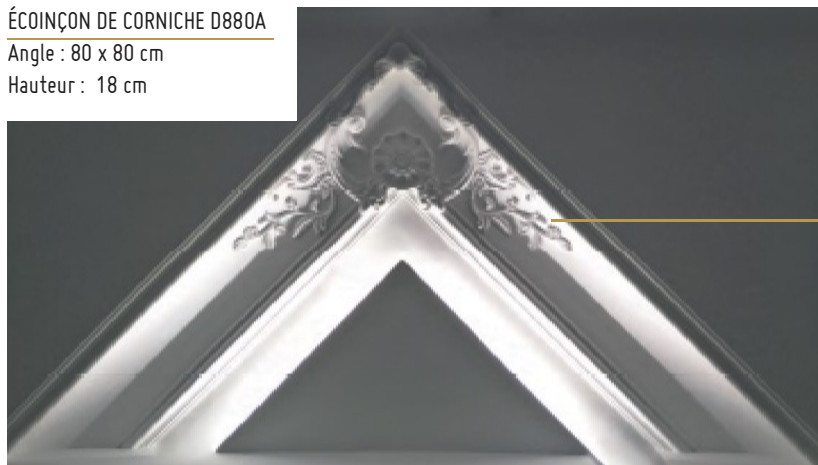

D880 (en 2 ml)

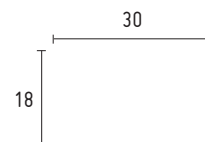

D654 (en 2 ml)

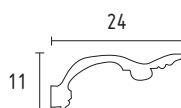

D651 (en 2 ml)

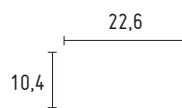

D652 (en 2 ml)

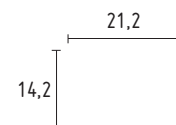

D650 (en 2 ml)

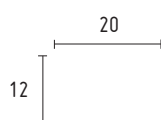

D606 (en 2 ml)

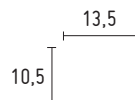

D624 (en 1,75 ml)

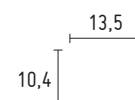

D616 (en 1,75 ml)

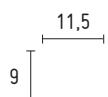

D607 (en 2 ml)

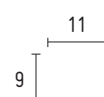

D702 (en 1,75 ml)

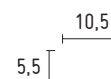

D623 (en 1,75 ml)

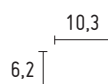

D622 (en 1,75 ml)

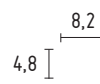

Pour les corniches D601, D606, D611, D616, D702, D707, vous pouvez leur associer un angle rentrant et sortant (par exemple, R601 et S601 pour la corniche D601...).

Angle rentrant  
R702

Angle sortant  
S702





CORNICHE D650  
PAGE 32

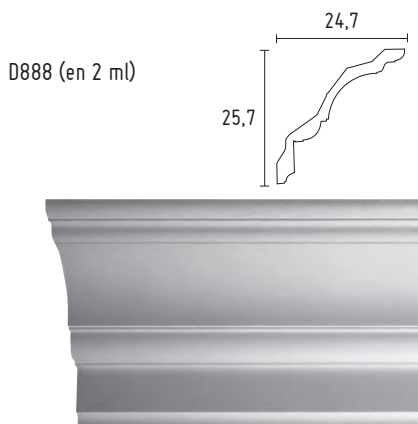
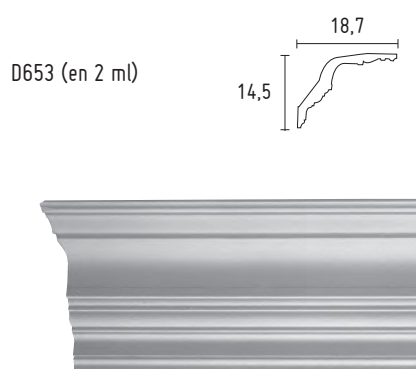
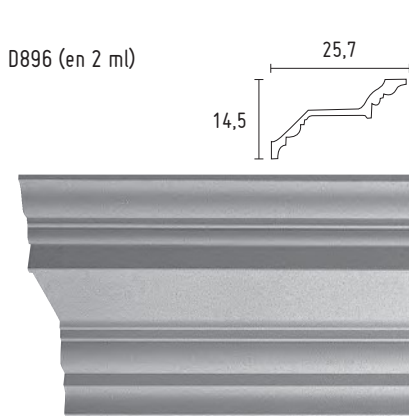
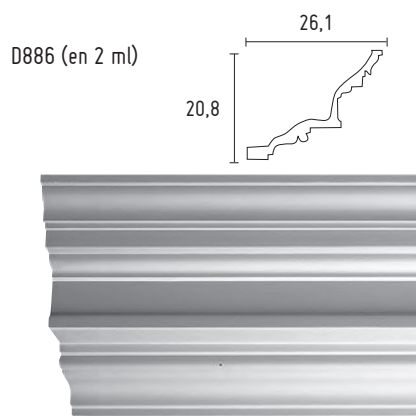

*Corniches pour  
grande  
hauteur  
sous plafond !*

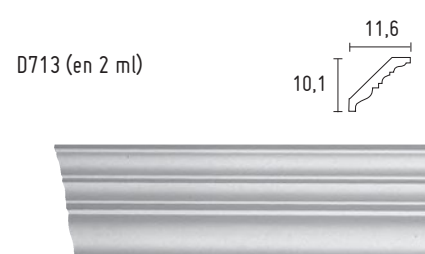
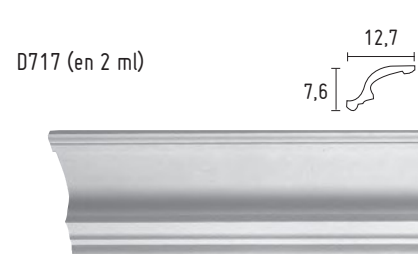
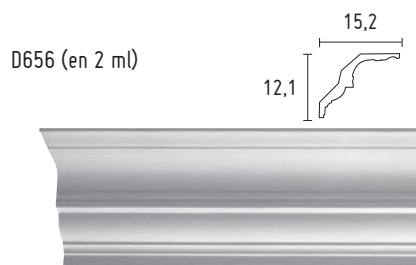
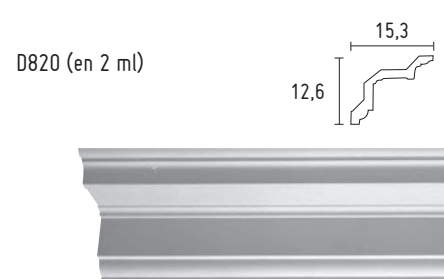
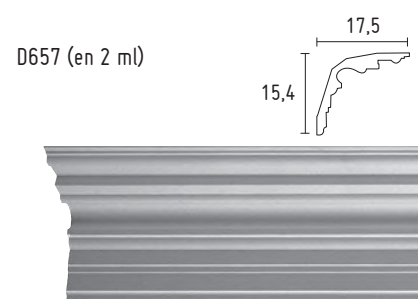
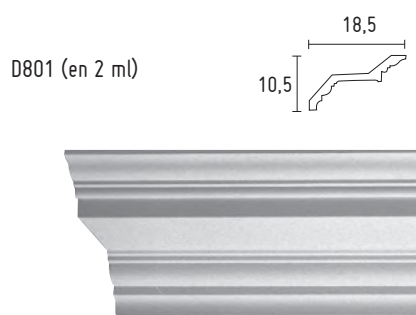

# CORNICHES ORNEMENTÉES

D899 (en 2 ml)

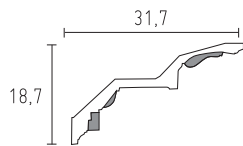

D898 (en 2 ml)

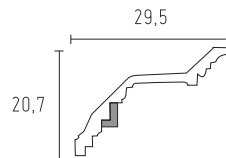

D889 (en 2 ml)

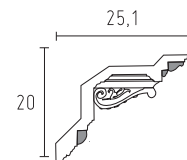

D815 (en 2 ml)

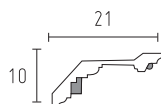

D814 (en 2 ml)

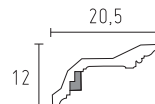

D569 (en 2 ml)

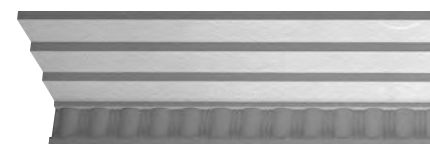
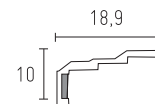

D810  
(en 2 ml)

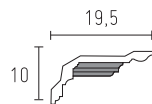

D515 (en 2 ml)

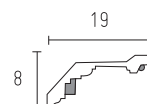

D902 (en 2 ml)

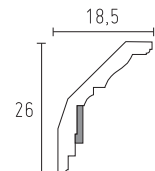

D628 (en 2 ml)

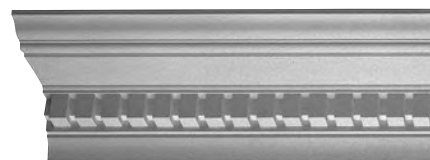
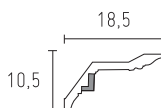

D629 (en 2 ml)

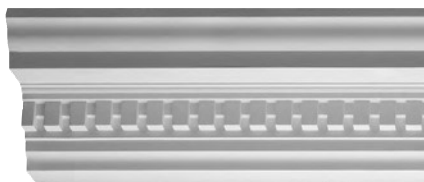
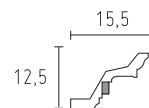

D531 (en 2 ml)

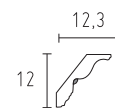

D840 (en 2 ml)

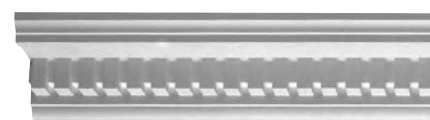
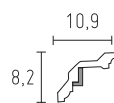

D715 (en 1,75 ml)

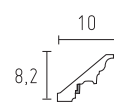

D617 (en 1,75 ml)

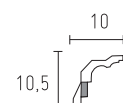

D897 (en 2 ml)

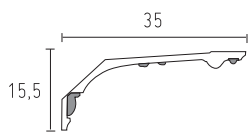

D895  
(en 2 ml)

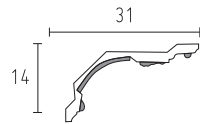

D885 (en 2 ml)

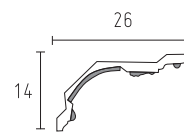

D894 (en 2 ml)

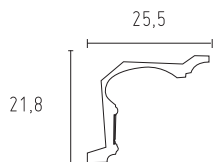

D893  
(en 2 ml)

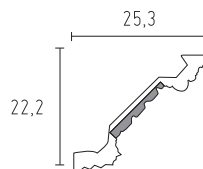

D884  
(en 2 ml)

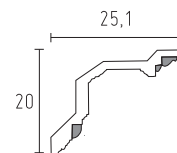

D844 (en 2 ml)

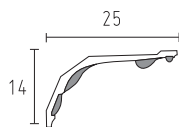

D570 (en 2 ml)

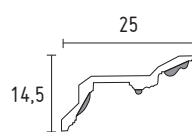

D566 (en 2 ml)

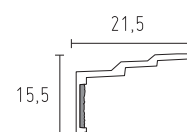

D843 (en 2 ml)

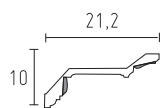

D813 (en 2 ml)

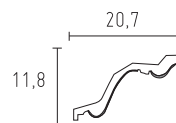

D510 (en 2 ml)

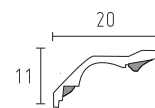

D812 (en 2 ml)

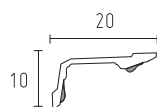

D505 (en 2 ml)

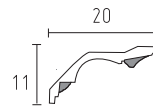

D845 (en 2 ml)

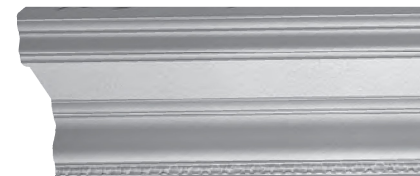
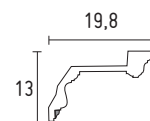



# CORNICHES ORNEMENTÉES

D846 (en 2 ml)

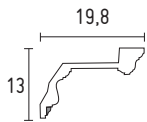

D627 (en 2 ml)

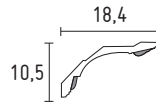

D716 (en 2 ml)

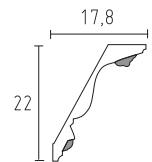

D835 (en 2 ml)

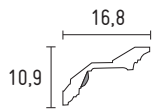

D818 (en 2 ml)

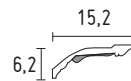

D712 (en 2 ml)

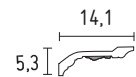

D615 (en 1,75 ml)

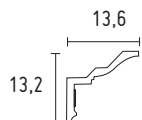

D655 (en 2 ml)

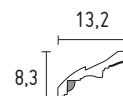

D530 (en 2 ml)



D513 (en 1,75 ml)



D525 (en 1,75 ml)



D535 (en 1,75 ml)



D711 (en 2 ml)

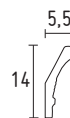

D540 (en 1,75 ml)



D550 (en 1,50 ml)



D890 (en 2 ml)

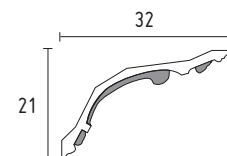

ÉCOINÇON DE CORNICHE D890A

Angle : 80 x 80 cm  
Hauteur : 21cm



*Feuilles d'angle  
pour corniches*

(Pour réf. D505, D510, D601)



R561



S562

## PLAQUES COFFRE

*Vendues en longueur de 1,5 ml*

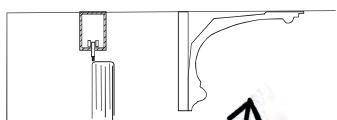

*Les petits + de nos  
plaques coffre :*

X Pour les finitions impeccables de vos coffres à rideaux associés à une corniche.

X Pour que vos corniches courent idéalement sur les trémies de vos escaliers.

X Pour faciliter la pose de vos parements !

- C080  
Plaque coffre haut.80 mm
- C090  
Plaque coffre haut.90 mm
- C0100  
Plaque coffre haut.100 mm
- C0105  
Plaque coffre haut.105 mm
- C0110  
Plaque coffre haut.110 mm
- C0120  
Plaque coffre haut.120 mm



Nos plaques coffre peuvent également être réalisées sur mesure dans nos ateliers (hauteur variable).



MOULURES 1301, 1302, 1303, & 1304  
en 1,50 ml  
PAGE 42

# LES MOULURES

MOULURE 1345  
en 2 ml  
PAGE 40  
© Château Mader

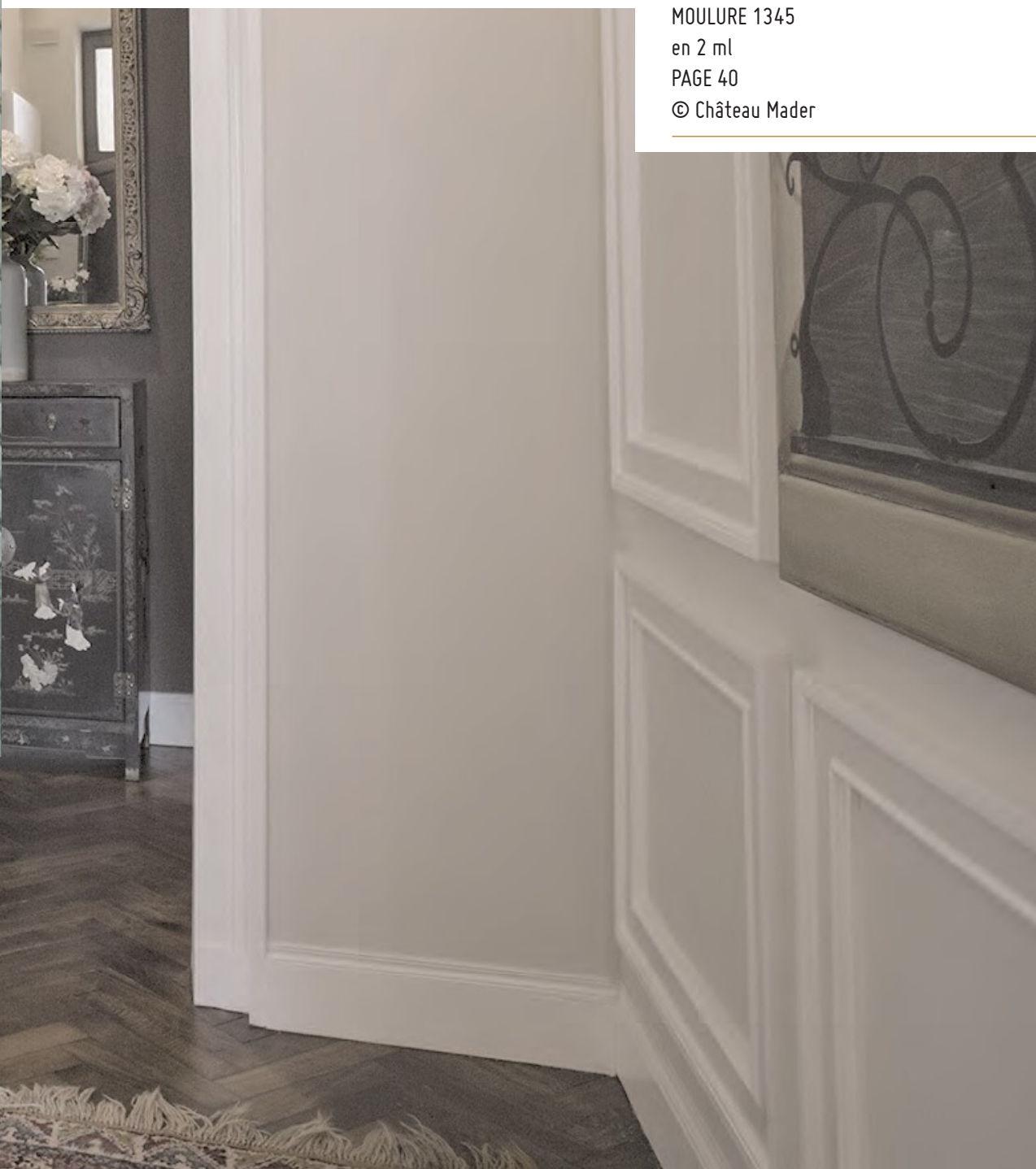

# MOULURES LISSES

1365 (en 1,75 ml)



1108 (en 2,15 ml)



1125 (en 2,15 ml)



1364 (en 2,15 ml)



1130 (en 2,15 ml)



1155 (en 1,50 ml)



1367 (en 2,15 ml)



1202 (en 1,50 ml)



1343 (en 1,50 ml)



1324 (en 2 ml)



1120 (en 2,15 ml)



1206 (en 1,50 ml)



1366 (en 2,15 ml)



1124 (en 2,15 ml)



1200 (en 1,50 ml)



1201 (en 1,50 ml)



1121 (en 2,15 ml)



1210 (en 1,75 ml)



1101 (en 1,50 ml)



1166 (en 1,50 ml)



1107 (en 1,50 ml)



1102 (en 1,50 ml)



1344 (en 1,50 ml)



1207 (en 1,50 ml)



1103 (en 1,50 ml)



1156 (en 1,50 ml)



1380 (en 1,50 ml)

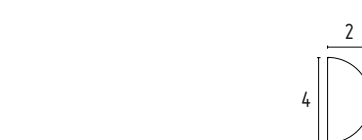

1209 (en 1,75 ml)



1345 (en 2 ml)

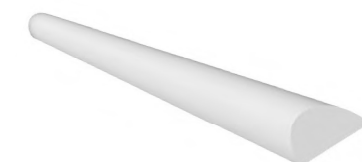

Retrouvez nos moulures de 2,15 ml (couvre-joints) page 106 !

MOULURE 1101  
en 1,50 ml  
PAGE 40



### *Le saviez-vous ?*



Toutes nos moulures contemporaines, classiques et ornementées peuvent être cintrées ! Confiez-nous vos plans et gabarits. Renseignez-vous auprès de votre agence Staff Décor et réalisons vos projets !

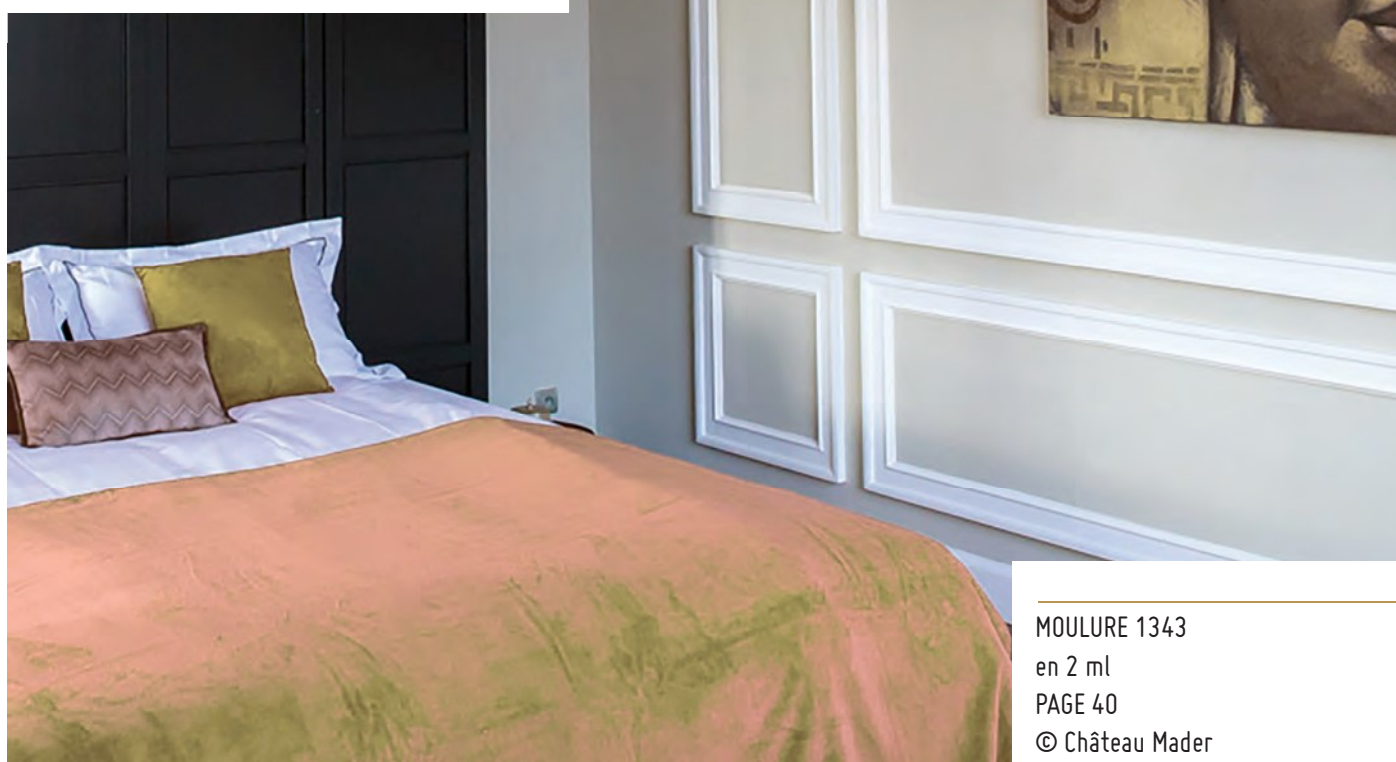

MOULURE 1343  
en 2 ml  
PAGE 40  
© Château Mader

# MOULURES ORNEMENTÉES

1208 (en 1,50 ml)

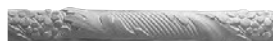

3,5

1110 (en 1,25 ml)



10,7

1111 (en 1,35 ml)



11,5

1112 (en 1,15 ml)



19,5

1113 (en 1,65 ml)



8,5

1205 (en 1,25 ml)



8,5

1104 (en 1,50 ml)



6

1105 (en 1,50 ml)



6

1106 (en 1,50 ml)



6,8

1109 (en 1,50 ml)



4,5

1114D ou 1114G (en 1,50 ml)



5,2

1204 (en 1,50 ml)



4

1157 (en 1,50 ml)



3

1150 (en 1,55 ml)



1151 (en 1,65 ml)



1301 (en 1,50 ml)

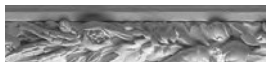

1302 (en 1,50 ml)



1303 (en 1,50 ml)



1304 (en 1,50 ml)



1305 (en 1,50 ml)



1306 (en 1,50 ml)



1310 (en 1,50 ml)



1321 (en 1,50 ml)



1322 (en 1,50 ml)



1323 (en 1,50 ml)



1325 (en 1,50 ml)



1326 (en 1,50 ml)



1327 (en 2,00 ml)



1328 (en 1,75 ml)



1329 (en 1,50 ml)



1330 (en 1,50 ml)



1331 (en 1,50 ml)



1332 (en 1,70 ml)



1333 (en 1,50 ml)



1340 (en 1,80 ml)



1374 (en 1,25 ml)

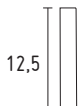
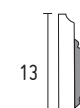
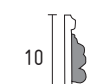
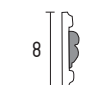

1341 (en 1,50 ml)



1342 (en 1,80 ml)

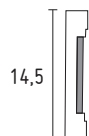

1346 (en 1,50 ml)

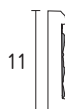

1347 (en 1,50 ml)



1348 (en 1,50 ml)



1349 (en 1,50 ml)



1203 (en 2 ml)



1334 (en 2 ml)



1335 (en 2 ml)



1371 (en 1,80 ml)



1320 (en 1,50 ml)



1373 (en 1,70 ml)



1372 (en 1,70 ml)



MOULURE 1102  
en 1,50 ml  
PAGE 40  
© Les fées Déco





ANGLE 1103D  
PAGE 46

# LES ANGLES & DOUCINES DE MOULURES

ANGLE 1204H

PAGE 47

© Hôtel Victor Hugo, Pontorson.



ANGLES & DOUCINES DE MOULURES

1150 (en 1,55 ml)

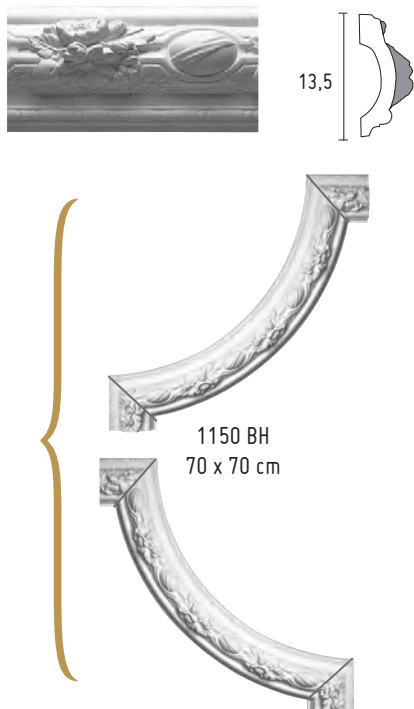

1151 (en 1,65 ml)

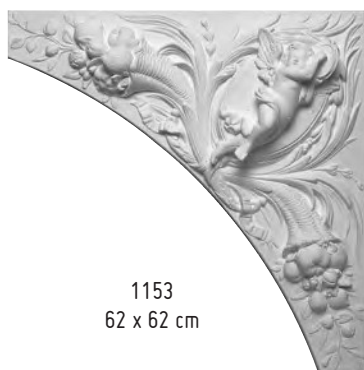
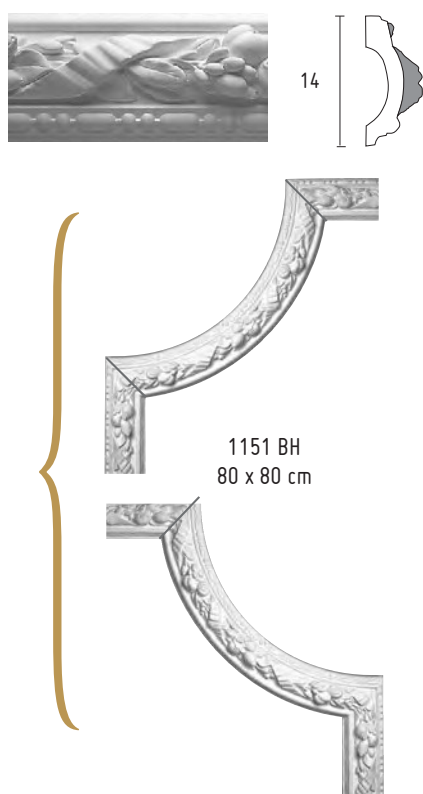

1104 (en 1,50 ml)

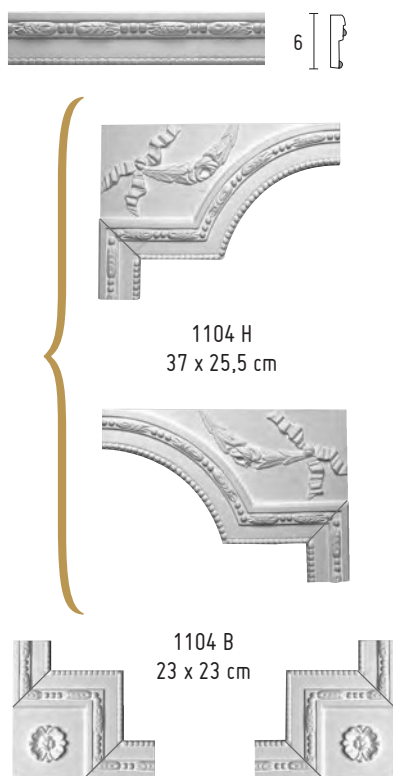

1105 (en 1,50 ml)

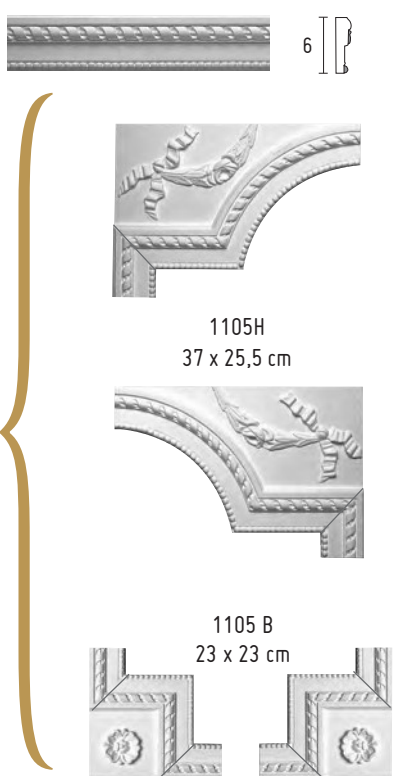

1200 (en 1,50 ml)

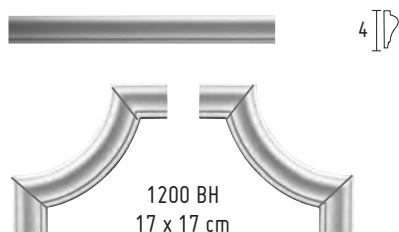

1103 (en 1,50 ml)

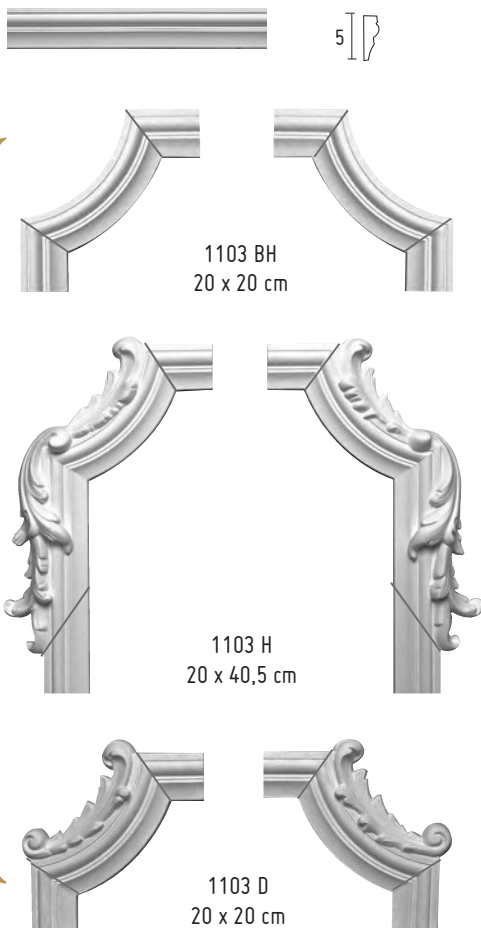

1210 (en 1,75 ml)

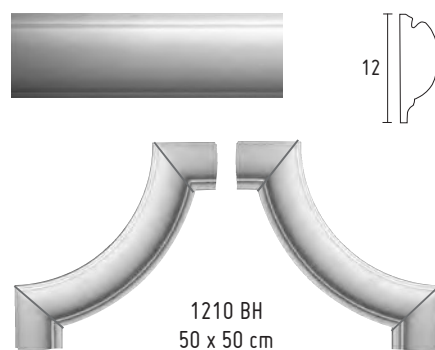

1206 (en 1,50 ml)

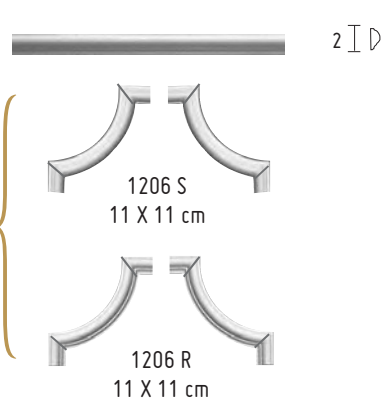

1204 (en 1,50 ml)

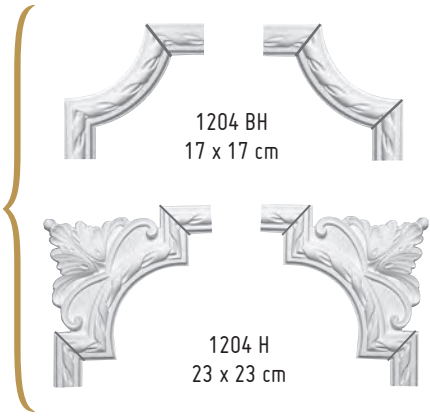

1102 (en 1,50 ml)

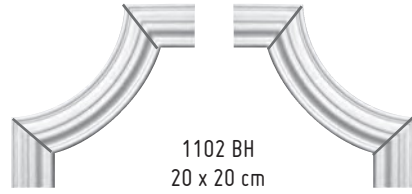

1107 (en 1,50 ml)

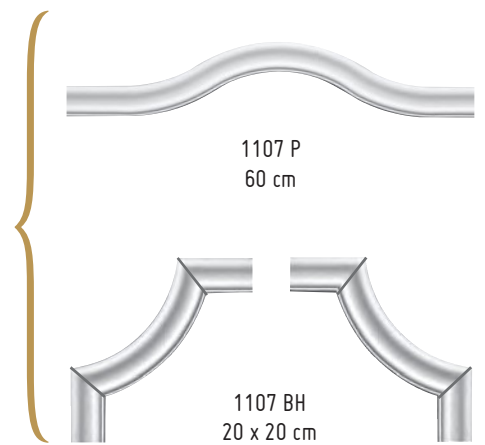

1101 (en 1,50 ml)

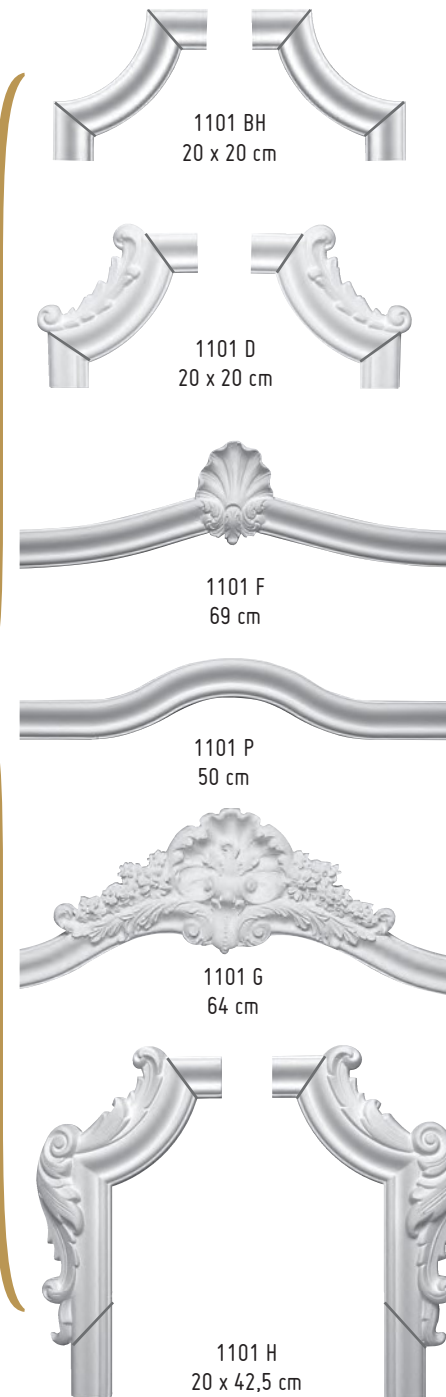

1207 (en 1,50 ml)

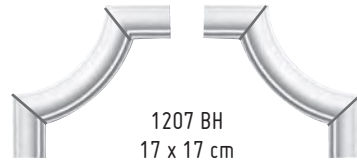

1208 (en 1,50 ml)

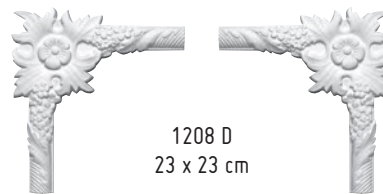

1202 (en 1,50 ml)

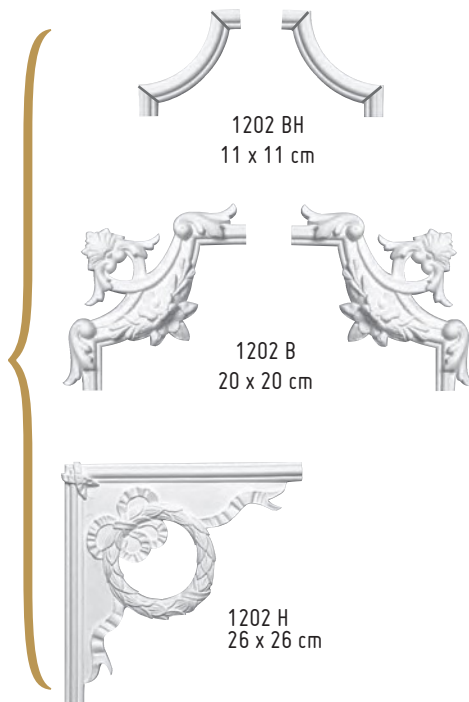

1420 M  
22 x 14 cm

1420 T  
28 x 17 cm



1420 H  
21 x 12 cm



1411 D  
8 x 12 cm



3800  
25,5 x 23,5 cm



1411 G  
8 x 12 cm



1410  
7,5 x 8,5 cm



1409  
13 x 18 cm



4200  
14 x 11 cm



4201  
11 x 17 cm



Mise en oeuvre

Pour la pose des angles, coupez les amorces comme indiqué ci-dessus par le trait gris.



CAISSONS 50.NIAG  
60 X 60 CM  
PAGE 65  
© The White House, Cannes

## GUIDE LÉGENDE



Rosace à coller ou pouvant être encastrée

# LES ROSACES & LES CAISSONS

ROSACE M301  
PAGE 54  
© Charles Cameron



# LES ROSETTES

---



1401 - ø 5,5 cm



1403 - ø 6 cm



1400 - ø 6 cm



M049 - ø 6 cm



1402 - ø 6,5 cm



1415 - ø 7 cm



1416 - ø 8 cm



1413 - 9 x 7 cm



1404 - ø 8,5 cm



1405 - ø 9 cm



M050 - ø 10 cm



1407 - 10,5 x 10,5 cm



1412 - ø 11,5 cm



1406 - ø 12 cm



1408 - ø 14 cm



M038 - ø 16 cm



1414 - ø 19 cm



M043 - ø 29 cm



M047 - ø 32 cm



M041 - ø 32 cm



M058 - ø 32,5 cm



M042 - ø 33 cm



M102 - ø 36 cm



M100 - ø 39 cm



M101 - ø 39 cm



M044 - ø 40 cm



M040 - ø 40 cm



M211 - ø 43,5 cm



ROSACES



M205 - ø 45 cm



M202 - ø 49 cm



M059 - ø 44 cm



M057 - ø 49 cm



M204 - ø 49 cm



M051 - ø 49,5 cm



M073 - ø 50 cm



M072 - ø 51 cm



M061 - ø 52 cm



M056 - ø 51,5 cm



M201 - ø 52 cm



M053 - ø 52 cm



M055 - 65 x 32 cm



M045 - 41 x 30 cm



M213 - ø 46 cm



M206 - ø 57 cm



M046 - 42 x 32 cm



M207 - 53 x 44 cm



M297 - ø 58 cm



M300 - ø 60 cm



M301 - ø 60 cm



M299 - ø 60 cm



M254 - ø 60 cm



M070 - ø 64 cm



M302 - ø 70 cm



M303 - ø 70 cm



M304 - ø 70 cm



M052 - ø 72,5 cm



 M401 - ø 90 cm



 M402 - ø 90 cm



 M403 - ø 87 cm





 M405 - ø 96 cm

ROSACE M405  
© Charles Cameron

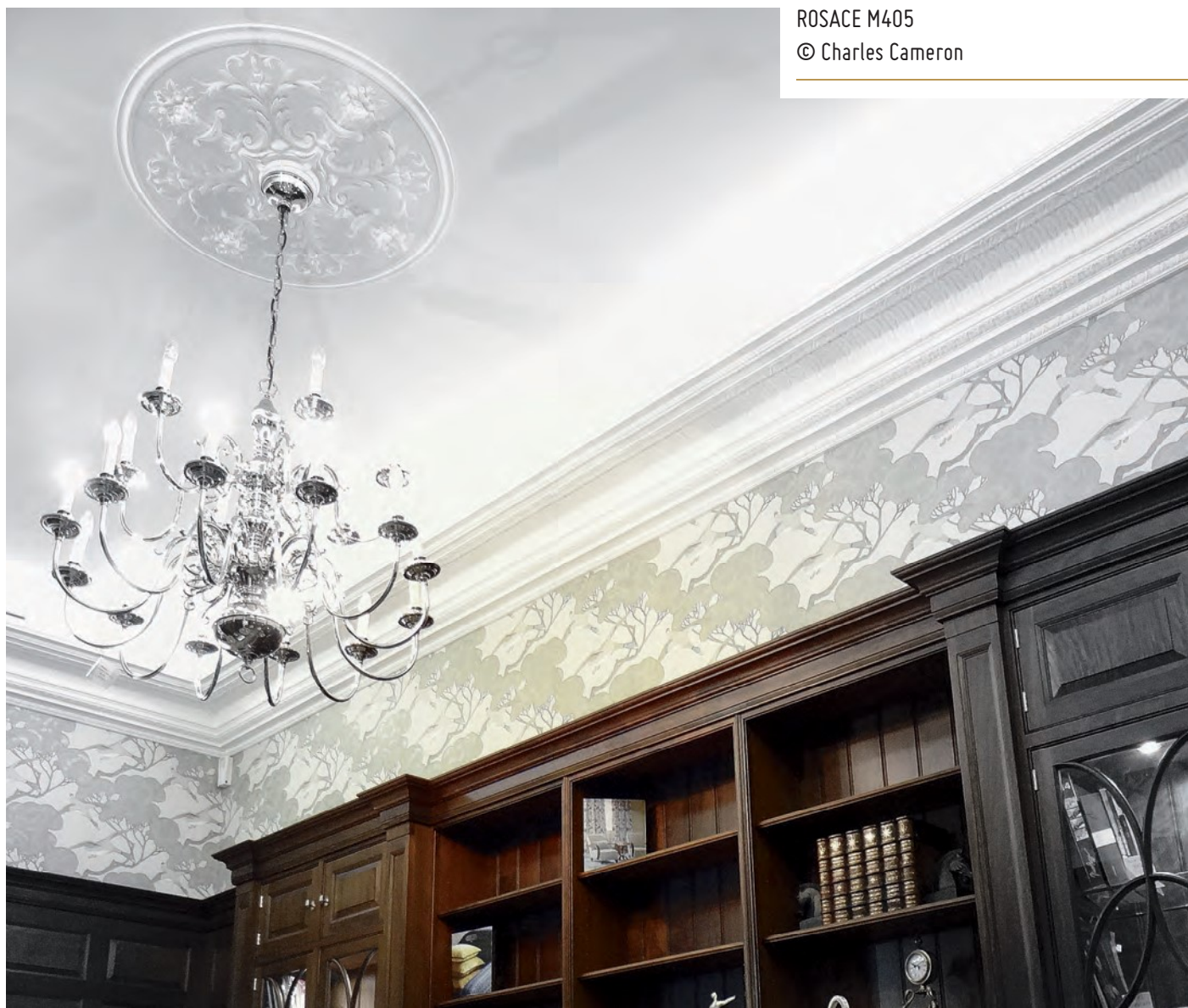



ROSACE M407



M407 - 124 x 80 cm





M209 - 64 x 48 cm



M071 - 88 x 74 cm



M210 - 60 x 41 cm



M068 - 55 x 39 cm



M039 - 59 x 38 cm



M069 - 72 x 42 cm



M203 - ø 50 cm



M048 - 57 x 32 cm



M208 - 51 x 40 cm





 M404 - ø 104 cm



 M067 - 91,5 x 46 cm



 M390 - 105 x 83 cm



 M255 - ø 84 cm



M296 - ø 63 cm



M406 - 84 x 44 cm



 M400 - 100 x 70 cm



M054 - 76 x 61 cm



M306 - ø 80 cm



M298 - 59 x 47 cm



M066 - ø 50 cm



M212 - ø 49 cm



M502 - 88,4 x 95,7 cm  
Livrée avec 3 hexagones en staff



M253 - ø 46 cm



M252 - ø 56 cm



M060 - ø 62 cm



M251 - ø 66 cm



M250 - ø 77 cm



ROSACE M501 - 80 x 80 cm  
© Hôtel Victor Hugo, Pontorson.

CARACTÉRISTIQUES  
TECHNIQUES

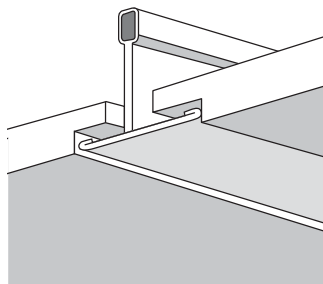

- > **Composition :** plâtre armé de fibre de verre.  
Matériau naturel ne contenant aucune substance toxique.
- > **Poids :** Selon les modèles,  
compris entre 9 et 22 Kg/m<sup>2</sup>.
- > **Réaction au feu :** classement M0 et A1  
Non Combustible.
- > **Type de montage :** Sur ossature semi-cachée  
selon schéma ci-contre ou  
scellement traditionnel.



CAISSON 50.NIAG  
60 x 60 cm  
© The White House, Cannes

50.NIAG  
60 x 60 cm  
Niagara - H 10 cm - 7,7 kg.



50.SIER  
60 x 60 cm  
Sierra - H 9 cm - 7,9 kg.



50.050  
60 x 60 cm  
H 2 cm - 7 kg.



50.ATLA  
60 x 60 cm  
Atlas - H 3 cm - 3kg.



STAFF DÉCOR peut également réaliser à la demande, tout modèle spécifique de caisson de plafond.



FRONTON B700  
PAGE 69

# LA COLLECTION ORIENTALE

MOULURE 1250G  
en 2 ml  
PAGE 68

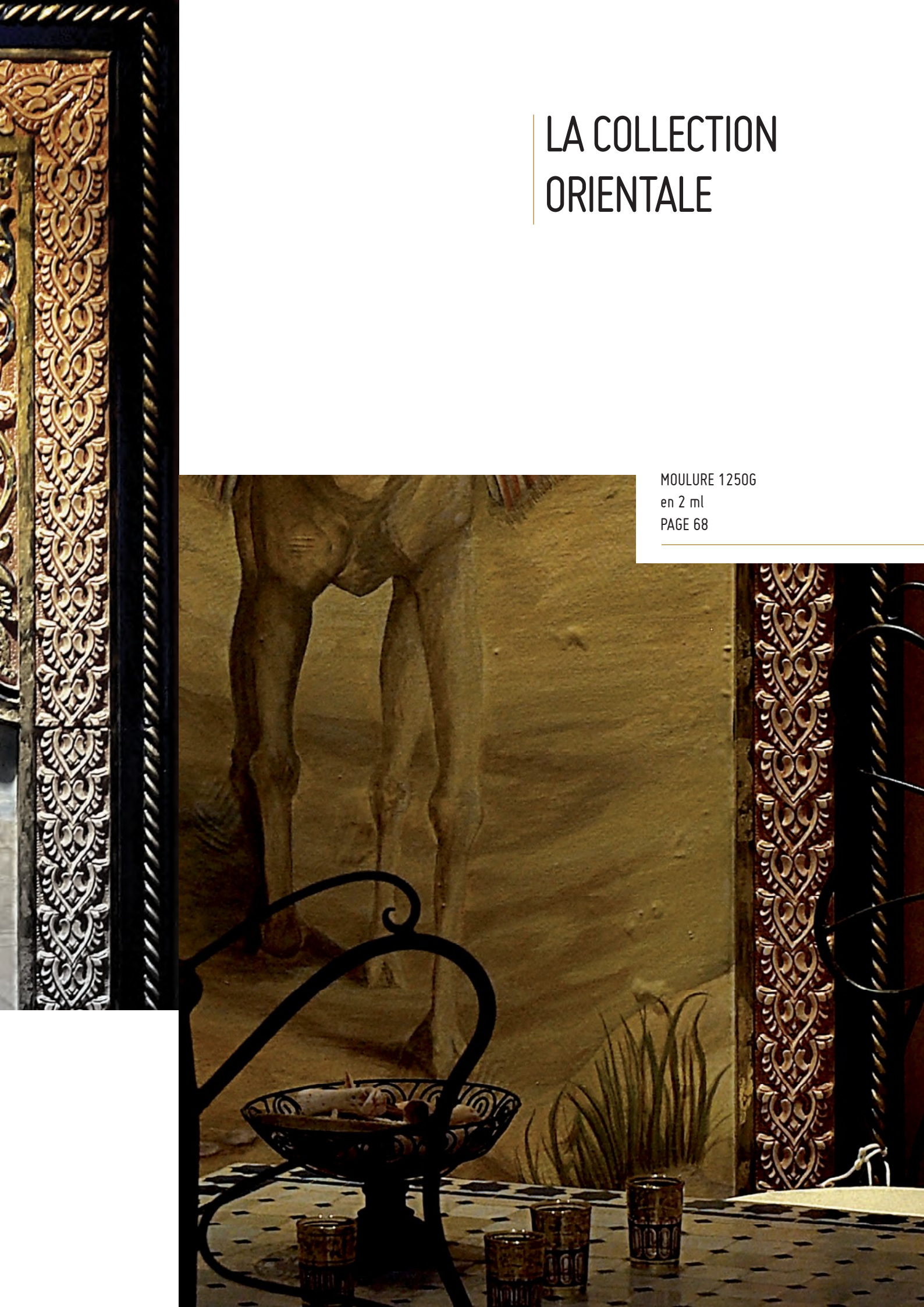



# MOULURES ET FRISES



1250G ou D  
L 200 cm x H 15 cm



1253  
L 210 cm x H 39 cm



1254  
L 215 cm x H 26 cm



1252  
L 187 cm x H 63 cm



1251  
L 209 cm x H 35 cm



1271  
22 x 19 cm

Les écoinçons sont livrés séparément. Ils sont destinés à faciliter les raccords et les arrêts de la frise.

## ABAT-JOUR



1275  
L 150 cm x H 45 cm



Abat-jour 201

# ROSACES



M421  
ø 83 cm



M422  
ø 100 cm



M420  
153 x 81 cm

# FRONTONS & CHAPITEAUX



B700  
Fronton 100 cm x 70 cm  
Flèche : 37 cm - corde : 71 cm



B702  
Fronton 166,5 cm x 68 cm  
Flèche : 52 cm - corde : 167 cm

1/2 chapiteau  
40.61  
22 cm x 11 cm x H 11 cm



B701  
Fronton 125 cm x 83 cm  
Flèche : 57 cm - corde : 95 cm

Demi-fût torsadé  
32.51  
ø 15 cm, H 200 cm



1/2 collerette basse  
45.51C



B703  
79 cm x 20,5 cm



CÔTÉ DE PASSAGE 2024  
PAGE 140

CIMAISE 1101C  
PAGE 103



FRONTON 3900

PAGE 106

TÊTE DE PILASTRE 0802

PAGE 116

PILASTRE 0800

PAGE 116

PAREMENTS

PAGE 74

LES  
MURS



© The White House, Cannes



|   |   |            |
|---|---|------------|
|     | <b>LES PAREMENTS</b>                          | <b>74</b>  |
|   | PIERRES ET BRIQUETTES                         | 76         |
|   | COLLECTION BOIS                               | 80         |
|   | COLLECTION CONTEMPORAINE                      | 81         |
|   | PANNEAUX DE GRANDES DIMENSIONS                | 92         |
| <br>  |   |            |
|    | <b>L'HABILLAGE MURAL PAR LAMBRISSAGE</b>      | <b>96</b>  |
|   | PLATE BANDE, ANGLES DE PLATE BANDE & CIMAISES | 98         |
|   | LAMBRIS DÉCAISSÉS                             | 99         |
|   | TÊTES POUR PILASTRES                          | 100        |
|   | INTERCALAIRES, STYLOBATES                     |            |
|   | ÉLÉMENTS DE CIMAISES, PLINTHES                | 101        |
|   | AUTRES SOLUTIONS POUR VOS SOUBASSEMENTS       | 102        |
| <br>  |   |            |
|   | <b>LES HABILLAGES DE PORTE</b>                | <b>104</b> |
|   | LE CONTEMPORAIN                               | 104        |
|   | LES CLASSIQUES                                | 105        |
|   | LES COUVRE-JOINTS                             | 106        |
|   | LES TALONS DE PORTE                           | 106        |
| <br>  |   |            |
|  | <b>LES FRONTONS</b>                           | <b>106</b> |
|   | FRONTONS RECTANGULAIRES                       | 106        |
|   | FRONTONS ORNEMENTÉS                           | 107        |
| <br>  |   |            |
|  | <b>LES COLONNES &amp; PILASTRES</b>           | <b>108</b> |
|   | LES COLONNES                                  | 108        |
|   | LES PILASTRES                                 | 113        |
|   | LES BALUSTRES                                 | 117        |



PAREMENT FACET  
CL31  
PAGE 86  
© Interlam

# LES PANNEAUX 3D & PAREMENTS

PAREMENT RR COLLECTION  
7063  
PAGE 91  
© Barbierri





## PIERRES & BRIQUETTES



7060  
Bruges  
87 x 60 cm  
Épaisseur : 1,5 cm  
Poids unitaire : 6,5 kg  
Conditionnement à l'unité  
avec briquettes de liaison



7061  
New-York  
93 x 54 cm  
Épaisseur : 1,5 cm  
Poids unitaire : 6,5 kg  
Conditionnement à l'unité



SD7054  
Brooklyn  
48,6 x 12,1 x 1,3 cm / unité  
Conditionnement : carton de 20 unités  
Vendu en carton de 0,92 m<sup>2</sup>  
Poids au m<sup>2</sup> : 13 kg



SD7047  
Soho  
9,8 x 50,8 x 1,5 cm / unité  
Conditionnement : carton de 25 unités  
Vendu en carton de 1 m<sup>2</sup>  
Poids au m<sup>2</sup> : 13,5 kg



SD7056  
Queens  
99,5 x 19 x 1,4 cm / unité  
Conditionnement : carton de 5 unités et  
10 briquettes de liaison  
Vendu en carton de 0,94 m<sup>2</sup>  
Poids au m<sup>2</sup> : 13 kg



SD7042  
Harlem  
100x20x1,5cm/unité  
Conditionnement : carton de 5 unités  
Vendu en carton de 1 m<sup>2</sup>  
Poids au m<sup>2</sup> : 13 kg



7038  
Tétris  
100 x 84 cm  
Épaisseur : 2 cm  
Poids unitaire : 10 kg  
Conditionnement à l'unité  
Surface : 0,71 m<sup>2</sup>



7040  
Pierre joint sec GM  
100 x 72,5 cm  
Épaisseur : 2 cm  
Poids unitaire : 8,5 kg  
Conditionnement à l'unité  
Surface : 0,56 m<sup>2</sup>

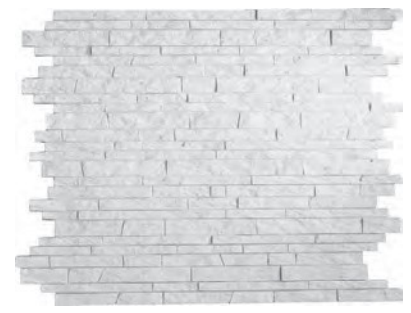

7041  
Pierre joint sec PM  
95 x 72cm  
Épaisseur : 2,4 cm  
Poids unitaire : 12,5 kg  
Conditionnement à l'unité  
Surface utile : 0,61 m<sup>2</sup>



7048  
Pierre de parement blanche  
7049  
Pierre de parement teintée

La finition blanche donne l'effet calcaire de la pierre du Gard. La finition teintée dans la masse rappelle la pierre de Tuffeau.

Aucun raccord apparent, les joints sont pré-moulés sur deux côtés du parement (joint vertical et horizontal).

Livrées par carton de 1 m<sup>2</sup> comprenant

- 1 élément 70 x 35 cm / épaisseur: 1,4 cm
- 1 élément 60 x 35 cm / épaisseur: 1,4 cm
- 1 élément 50 x 35 cm / épaisseur: 1,4 cm
- 2 éléments 40 x 35 cm / épaisseur: 1,4 cm
- 3 éléments 12 x 35 cm / épaisseur: 1,4 cm

Poids du carton : 14 kg

Pour les finitions :



3,2  
8,4

7051 (en 1,50 ml) Moulure pierre teintée  
7053 (en 1,50 ml) Moulure pierre blanche

Talon TALP  
épaisseur 4 cm

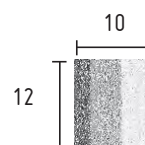

PAREMENTS 7041  
PAGE 76

## COMMENT UTILISER NOS PAREMENTS ?

POUR CLOISONNER OU SÉPARER...



PAREMENT 7073  
PAGE 82

POUR VOS FINITIONS...  
DESSINEZ UN BAR OU UN COMPTOIR...



PAREMENT CL32  
PAGE 87  
© Interlam

## POUR UNE TÊTE DE LIT..

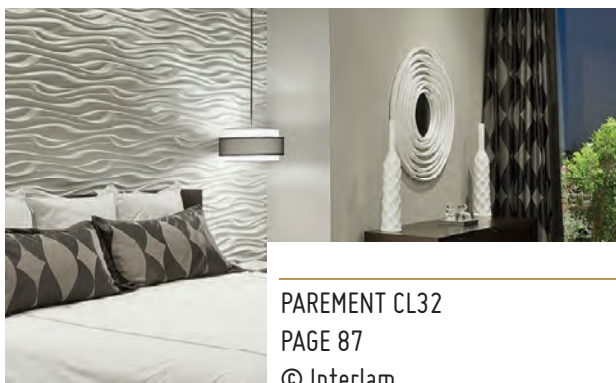

## POUR REMPLACER UN TABLEAU...

PAREMENT SD7055  
PAGE 84



### CONSEIL DE POSE :

Pose par collage avec enduit cellulosique de type "Staff Décor"

Les finitions de nos produits sont en plâtre brut et prêts à peindre.

## POUR HABILLER VOS CHEMINÉES...

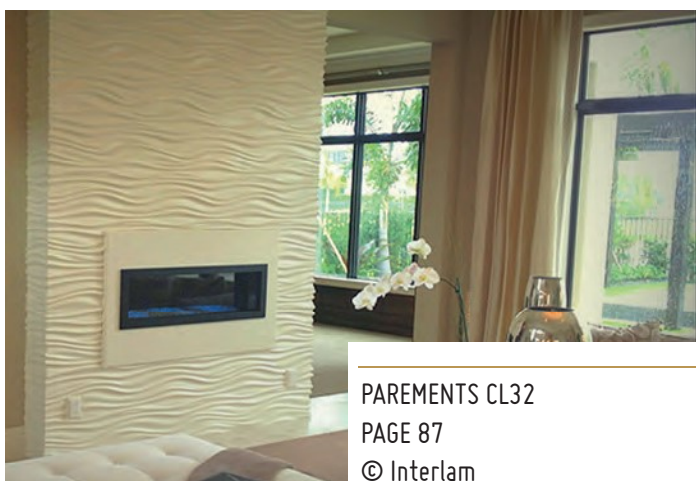

DIY ?

Scannez &  
suivez notre tutoriel !



# LES BOIS



PAREMENT SD7043



SD7043  
Forest Hill (Brique)te)  
100 x 20,8 x 1,8 cm / unité  
Conditionnement : carton de 5 unités  
Vendu en carton de 0,94 m<sup>2</sup>  
Poids au m<sup>2</sup> : 15 kg

SD7044  
Forest Hill (Lame)  
100 x 10 x 1,3 cm / unité  
Conditionnement : carton de 10 unités  
Vendu en carton de 1m<sup>2</sup>  
Poids au m<sup>2</sup> : 13,6 kg



SD7052  
Greenwich  
99 x 19,2 x 1,4 cm / unité  
Conditionnement : carton de 5 unités  
et 10 briquettes de liaison  
Vendu en carton de 0,94 m<sup>2</sup>  
Poids au m<sup>2</sup> : 13 kg

SD7057  
120 x 25 x 1,4 cm / unité  
Conditionnement : carton de 2 unités  
Vendu en carton de 0,6 m<sup>2</sup>  
Poids au m<sup>2</sup> : 15 kg

## COLLECTION CONTEMPORAINE

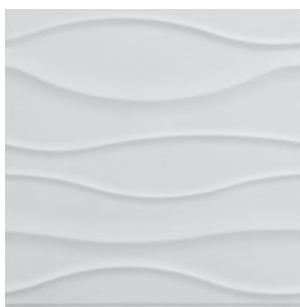

SD7500  
Key West



SD7501  
Daytona



SD7502  
Square Garden

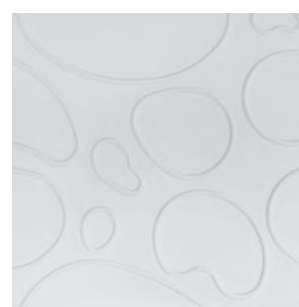

SD7503  
Everglades

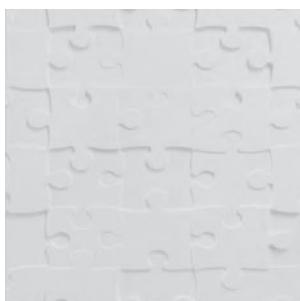

SD7504  
Orlando

### GAMME « JOINTS CREUX »

Caractéristiques techniques communes à l'ensemble de la gamme :

60 x 60 cm / unité

Conditionnement : carton de 2 éléments

Poids du carton : 13 kg sauf SD7500 à 12 kg

Vendu en carton de 0,72 m<sup>2</sup>

Pose par collage avec enduit cellulosique "StaffDécor"

Finition : plâtre brut

Le produit est prêt à peindre.

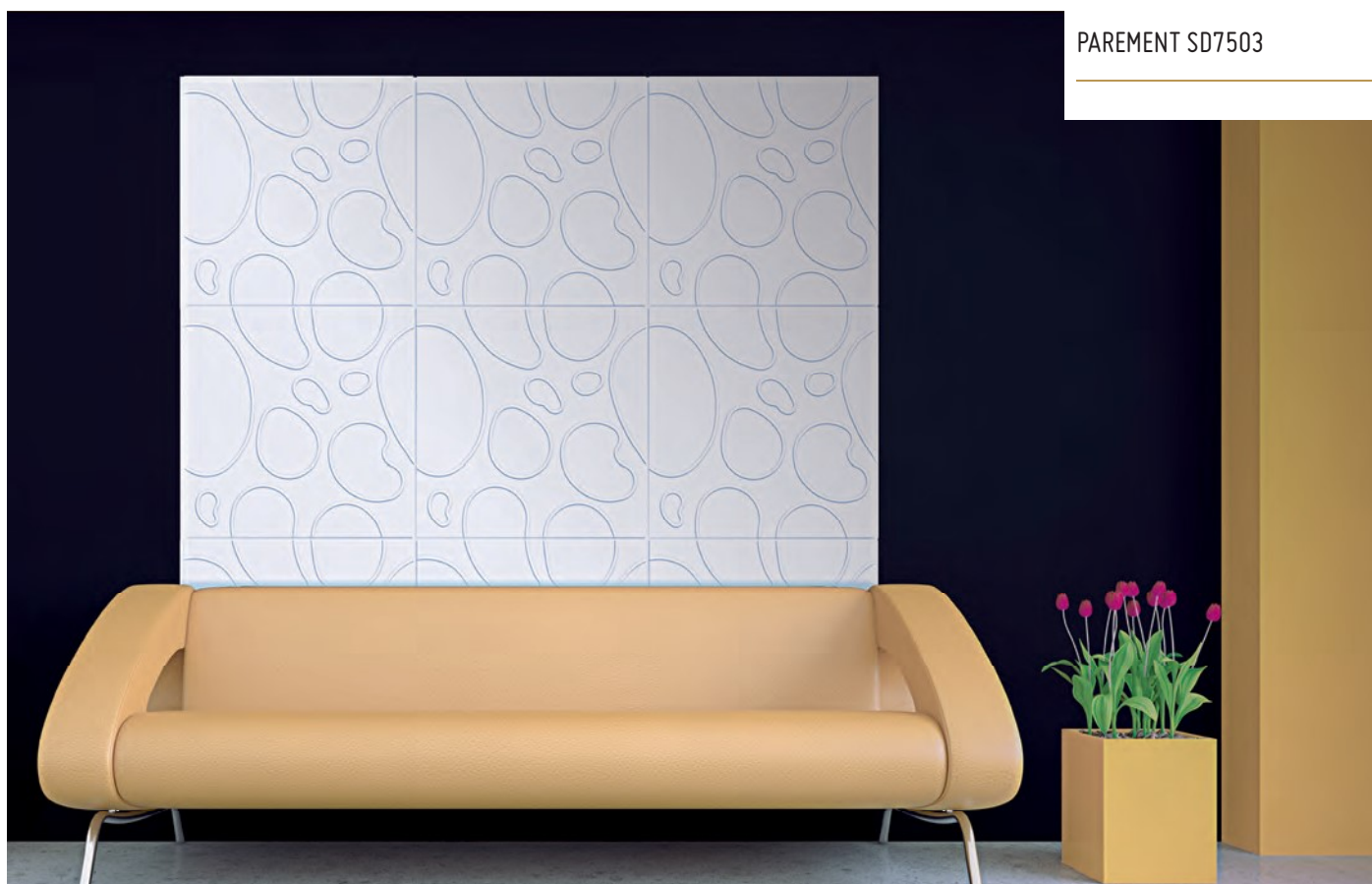

PAREMENT SD7503

## PAREMENTS

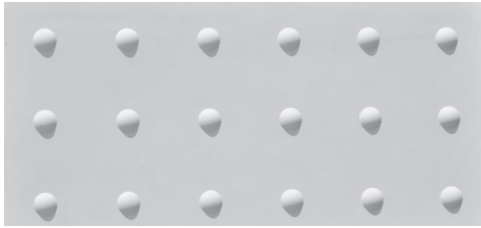

7070  
Panneau Bulles  
120 x 60 cm  
Epaisseur : 1,25 cm min / 2,3 cm max  
Poids unitaire : 9,5 kg  
Conditionnement à l'unité  
© Design by Lionel Brehelin

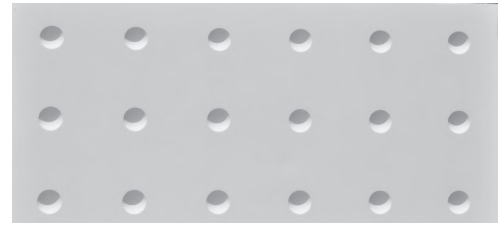

7071  
Panneau Golf  
120 x 60 cm  
Epaisseur : 1,25 cm  
Poids unitaire : 9,1 kg  
Conditionnement à l'unité  
© Design by Lionel Brehelin

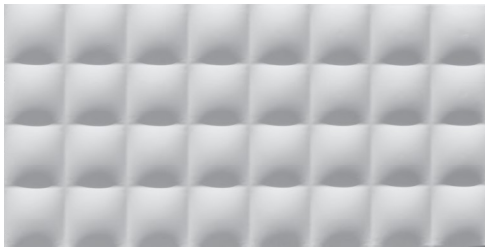

7072  
Panneau Capitons  
120 x 60 cm  
Epaisseur : 1,25 cm min / 2,3 cm max  
Poids unitaire : 13,5 kg  
Conditionnement à l'unité  
© Design by Lionel Brehelin



7073  
Panneau Macarons  
120 x 60 cm  
Epaisseur : 1,25 cm  
Poids unitaire : 9,2 kg  
Conditionnement à l'unité  
© Design by Lionel Brehelin



7074  
Panneau Virgules  
120 x 60 cm  
Epaisseur : 1,25 cm  
Poids unitaire : 9,3 kg  
Conditionnement à l'unité  
© Design by Lionel Brehelin



7075  
Panneau Caro  
120 x 60 cm  
Epaisseur : 1,25 cm  
Poids unitaire : 9,2 kg  
Conditionnement à l'unité  
© Design by Lionel Brehelin



PAREMENT 7072

PAGE 82

© Design by Lionel Brehelin



## PAREMENTS



50.LET1  
Dalle palmier droite  
40 x 40 cm  
Epaisseur : 1,5 cm  
Conditionnement à l'unité  
Poids unitaire : 3kg  
© Design by Patrick le Tuault



50.LET2  
Dalle palmier gauche  
40 x 40 cm  
Epaisseur : 1,5 cm  
Conditionnement à l'unité  
Poids unitaire : 3kg  
© Design by Patrick le Tuault



50.LET3  
Dalle palmier  
40 x 40 cm  
Epaisseur : 1,5 cm  
Conditionnement à l'unité  
Poids unitaire : 3kg  
© Design by Patrick le Tuault



SD7045  
Luna Park (Lame)  
100 x 20 x 1,3 cm / unité  
Conditionnement : carton de 5 unités  
Vendu en carton de 1 m<sup>2</sup>  
Poids au m<sup>2</sup> : 13 kg



SD7055  
Broadway  
40 x 40 x 2 cm / unité  
Conditionnement : carton de 6 unités  
Vendu en carton de 0,96 m<sup>2</sup>  
Poids au m<sup>2</sup> : 12 kg



7078  
Panneau Diamants

120 x 60 cm  
Epaisseur : 0,9 cm min / 1,9 cm max  
Poids unitaire : 9,85 kg  
Conditionnement à l'unité

Besoin de conseils pour le  
choix de vos parements ?  
Découvrez notre article et  
*inspirez-vous !*



SD7046  
V<sup>ème</sup> avenue  
40 x 40 x 1,5 cm / unité  
Conditionnement : carton de 6 unités  
Vendu en carton de 0,96 m<sup>2</sup>  
Poids au m<sup>2</sup> : 13 kg

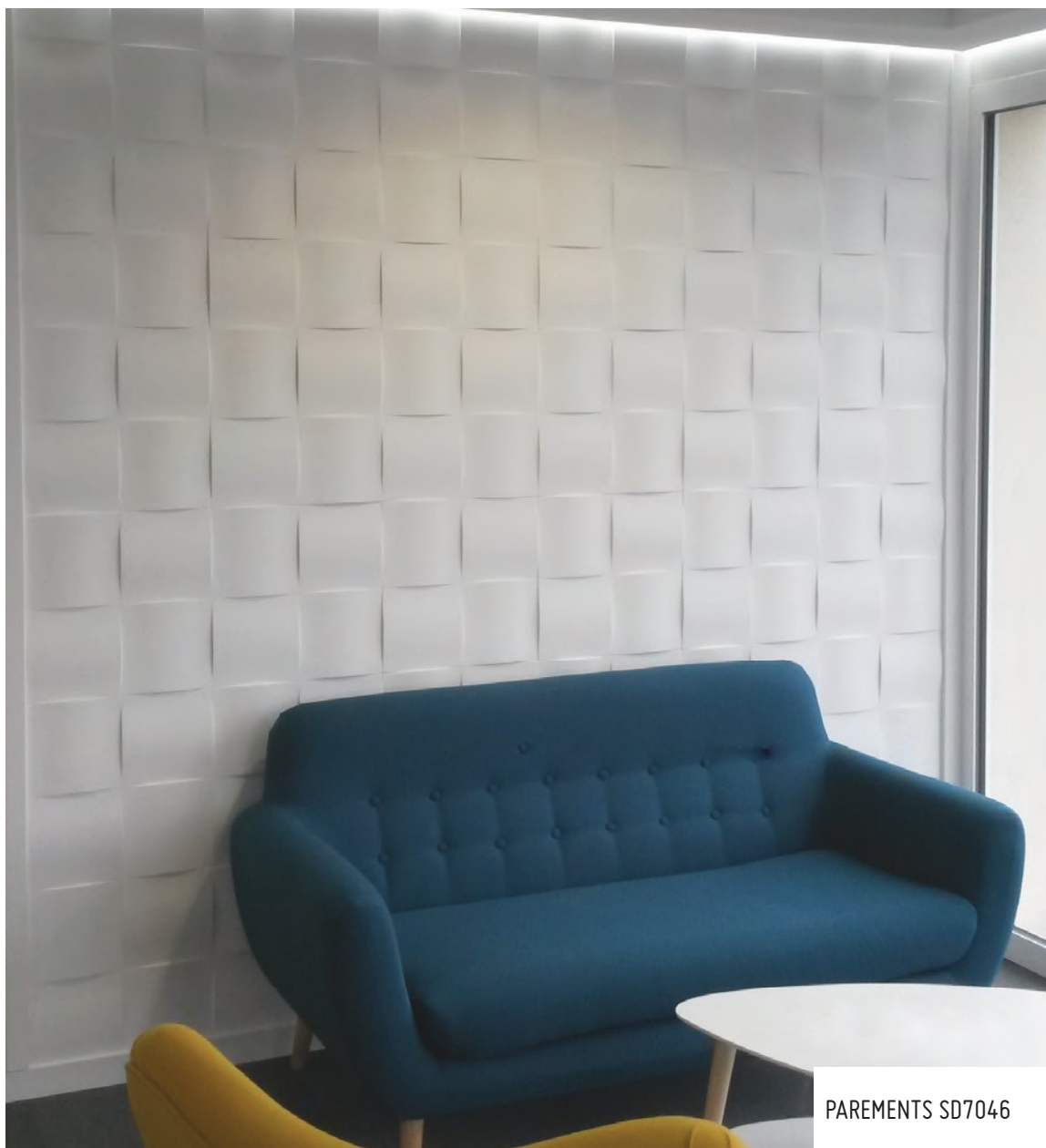
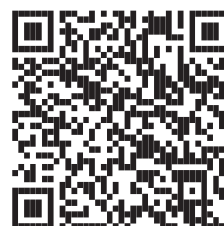

PAREMENTS SD7046

# Nos best-of



CL31A et B  
Facet  
122 x 122 cm  
Conditionnement à l'unité  
Epaisseur : 2 cm  
Surface : 1,49 m<sup>2</sup> /plaque  
Poids unitaire : 23 kg  
© Design by Interlam

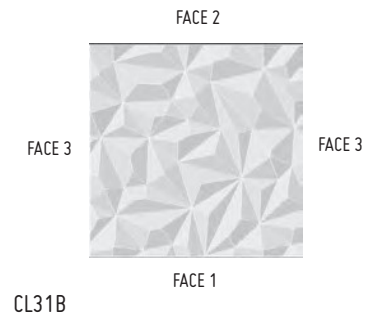
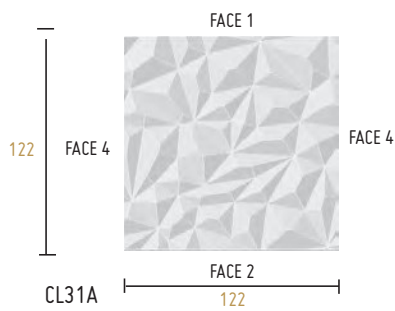



PAREMENT CL32  
© Interlam



CL32  
Vague relief  
122 x 122 cm  
Conditionnement à l'unité  
Épaisseur : 1,6 à 3,5 cm  
Surface : 1,49 m<sup>2</sup> / plaque  
Poids unitaire : 16 kg  
© Design by Interlam

CL33  
Cloud  
122 x 122 cm  
Conditionnement à l'unité  
Épaisseur : 1,2 à 3 cm  
Surface : 1,49 m<sup>2</sup> / plaque  
Poids unitaire : 16 kg  
© Design by Interlam

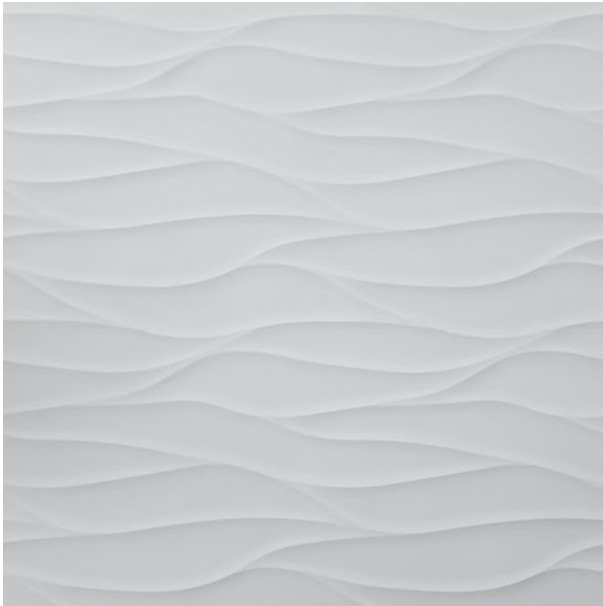

CL34  
Bio  
122 x 122 cm  
Conditionnement à l'unité  
Épaisseur : 3 à 3,7 cm  
Surface : 1,49 m<sup>2</sup> / plaque  
Poids unitaire : 18 kg  
© Design by Interlam



CL35  
Crystal  
122 x 122 cm  
Conditionnement à l'unité  
Épaisseur : 3 à 3,7 cm  
Surface : 1,49 m<sup>2</sup> / plaque  
Poids unitaire : 18 kg  
© Design by Interlam



CL36  
Prisme  
122 x 122 cm  
Conditionnement à l'unité  
Épaisseur : 3,2 cm  
Surface : 1,49 m<sup>2</sup> / plaque  
Poids unitaire : 18 kg



PAREMENTS 7035

Labrys

Plaque de 30,4 x 48,15 cm  
Conditionnement à l'unité  
Épaisseur : 3,6 cm  
Surface : 0,09 m<sup>2</sup>  
Poid unitaire : 3,2 kg/plaque  
© Design by Interlam

# SOLUTION D'HABILLAGES CLÉ EN MAIN

*Une plaque  
de parement*

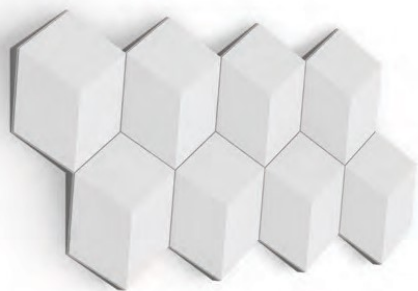

7036  
Multiface  
Plaque de 8 carreaux de 106,6 x 47,9 cm  
Conditionnement à l'unité  
Épaisseur : 3,7 cm  
Surface : 0,4 m<sup>2</sup>  
Poids unitaire : 9,6 kg  
© Design by Interlam

*des pièces  
individuelles*



7036U  
1 carreau de 23,6 x 27,4 cm  
Conditionnement à l'unité  
Épaisseur : 3,7 cm  
Surface : 0,05 m<sup>2</sup>  
Poids unitaire : 1,2 kg  
© Design by Interlam

*Une plinthe  
mise en forme*



7036PLIN  
Plinthe de 1,42 ml  
Conditionnement à l'unité  
Hauteur : 16,9 cm  
Épaisseur : 2,2 cm  
Surface : 0,19 m<sup>2</sup>  
Poids unitaire : 2,8 kg  
© Design by Interlam

PAREMENT 7036  
Multiface  
© Interlam

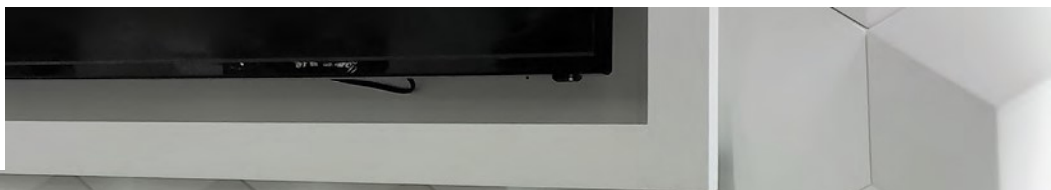

## LES PAREMENTS SIGNÉS GIOVANI BARBIERRI



7039A  
44 x 44 cm – épaisseur : 3,5 cm environ  
Conditionnement à l'unité  
Surface : 0,12 m<sup>2</sup>  
Poids unitaire : 2,7 kg soit 22,5 kg/m<sup>2</sup> environ  
© Barbierrri



7039B  
44 x 44 cm – épaisseur : 3,5 cm environ  
Conditionnement à l'unité  
Surface : 0,12 m<sup>2</sup>  
Poids unitaire : 2,7 kg soit 22,5 kg/m<sup>2</sup> environ  
© Barbierrri

*Composez en fonction de vos envies !*

PAREMENTS 7039A & 7039B  
FLOWER

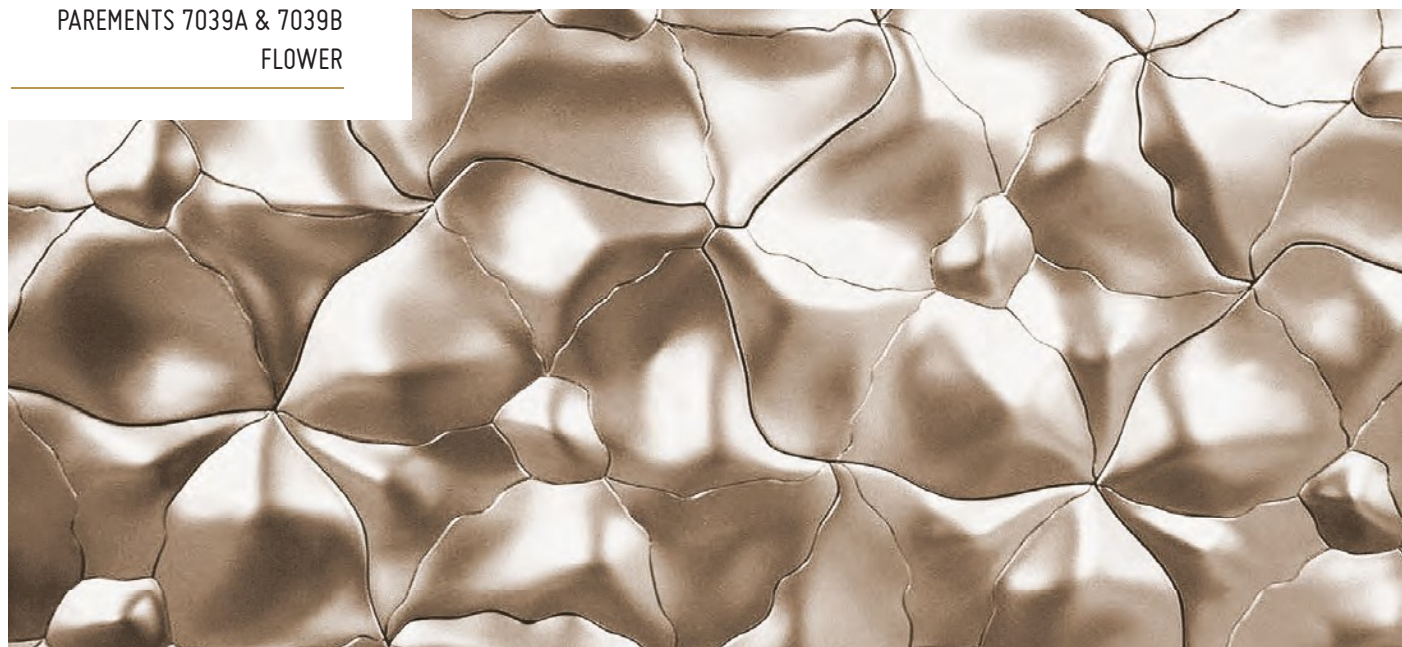



PAREMENTS 7062  
MOSAÏC

66 x 16 cm – épaisseur : 1,7 cm

Surface : 0,10 m<sup>2</sup>

Poids unitaire : 1,45 kg

Conditionnement : vendu en carton de 1 m<sup>2</sup>

© Barbiéri



Détail du raccord

*Scannez pour découvrir nos  
solutions de calepinage !*



À partir de 4 matrices différentes, composez vous-même un  
habillage mural à votre image !



PAREMENTS 7063  
RR COLLECTION

40,5 x 29,4 cm

Épaisseur variable en fonction du motif. Entre 1,3 cm et 2,5 cm.

Poids unitaire : 1,45 kg

Conditionnement :  
vendu en carton de 1 m<sup>2</sup>

7063-1 : Motifs plats

7063-2 : Motifs plats et incurvés

7063-3 : Motifs incurvés et bombés

7063-4 : Motifs bombés

© Barbiéri





## LES PANNEAUX GRANDES DIMENSIONS

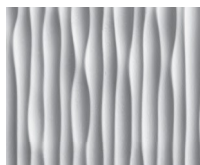
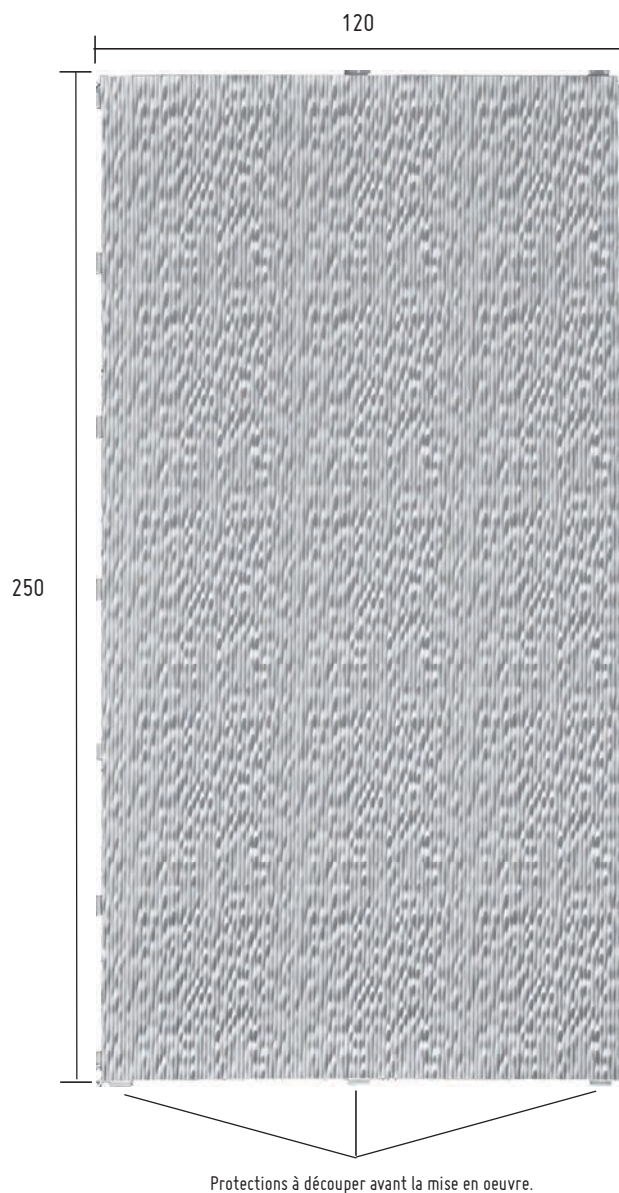

CL10  
Motif vertical  
Dimensions : 120 x 250 cm  
Conditionnement à l'unité  
Surface : 3 m<sup>2</sup>  
Poids unitaire : 18 kg.

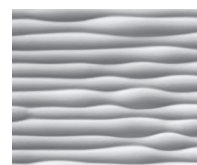

CL11  
Motif horizontal  
Dimensions : 120 x 250 cm  
Conditionnement à l'unité  
Surface : 3 m<sup>2</sup>  
Poids unitaire : 18 kg.



### Mise en oeuvre :

Collage des panneaux à l'enduit STAFF DECOR (seau de 10 kg, référence 0010) sur les supports courants (plâtre, béton, plaque de plâtre ...).

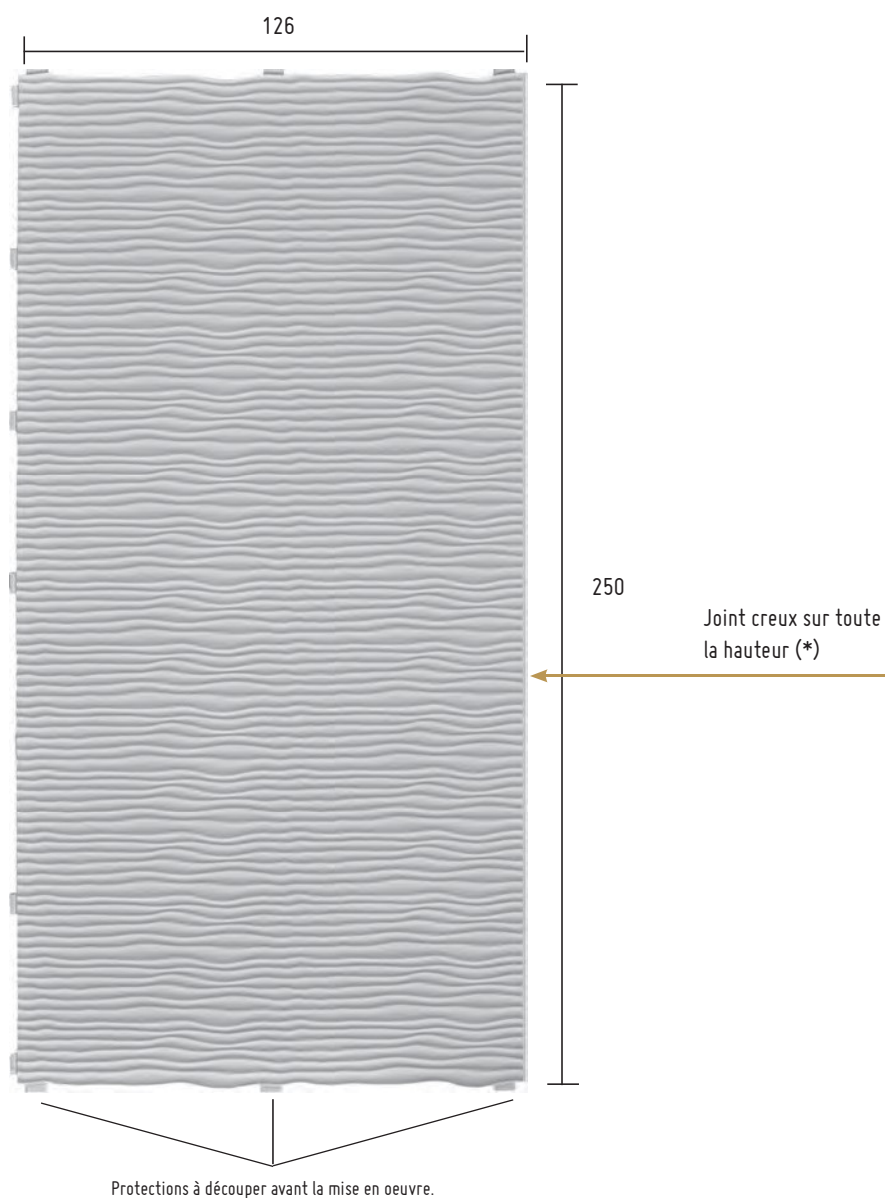

CL1374  
 Dimensions : 126 x 250 cm  
 Conditionnement à l'unité  
 Surface : 3,15 m<sup>2</sup>  
 Poids unitaire : 18 kg.



Zoom  
 sur le joint creux.

\*Le panneau référence CL1374 présente un joint creux d'une largeur de 1 cm sur un côté. Pour un résultat sans raccord apparent (bord à bord), ce joint doit être découpé.

Pensez à composer :  
 Découvrez la moulure **1374** afin d'accompagner votre parement !  
 (page 42 de notre catalogue)



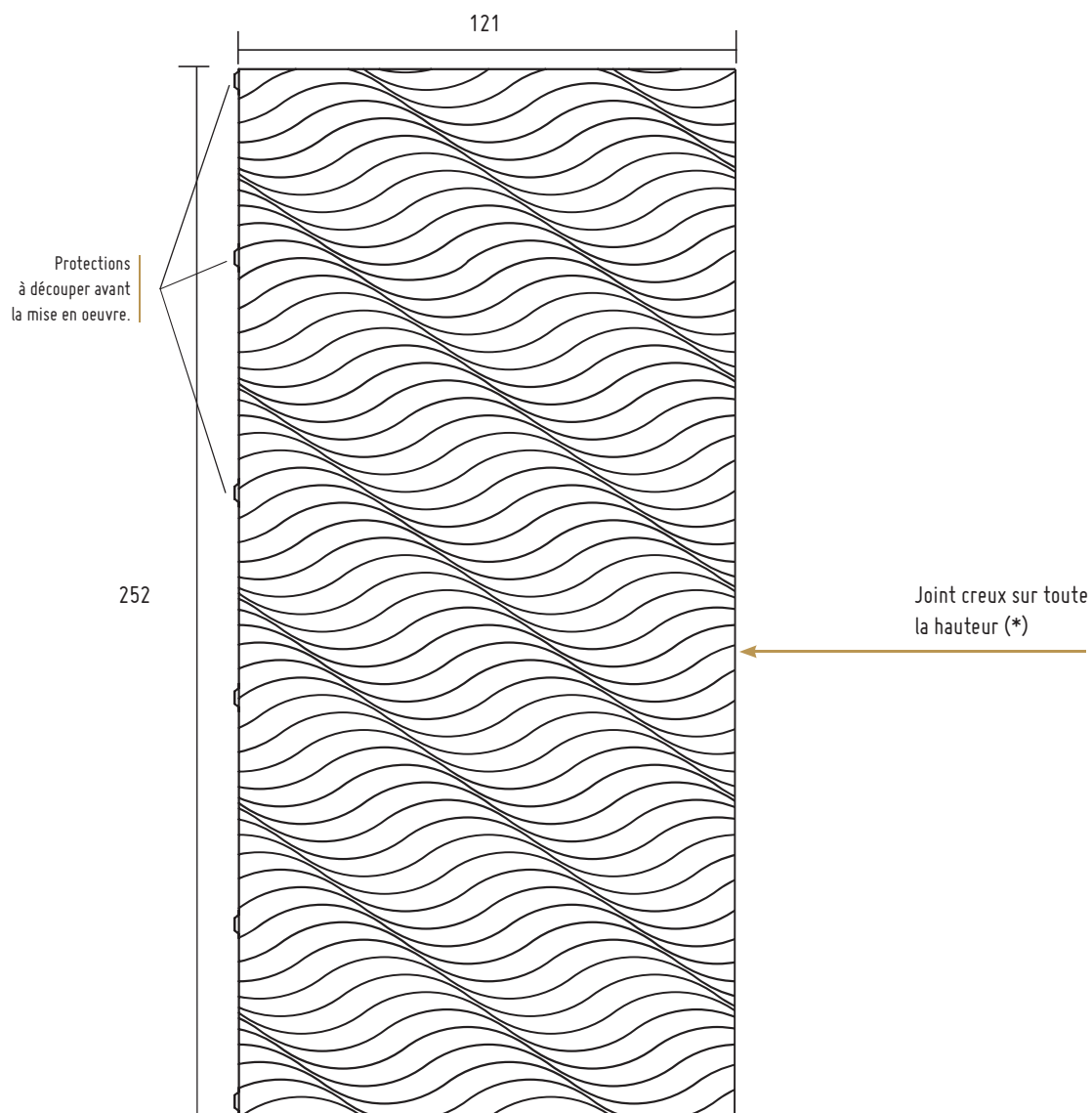

CL12 Ondes  
Dimensions : 121 x 252 cm  
Conditionnement à l'unité  
Surface : 3,05 m<sup>2</sup>  
Poids unitaire : 18 kg.



\*Le panneau référence CL12 présente un joint creux d'une largeur de 1 cm sur un côté. Pour un résultat sans raccord apparent (bord à bord), ce joint doit être découpé.



PAREMENT CL1374  
Page 93

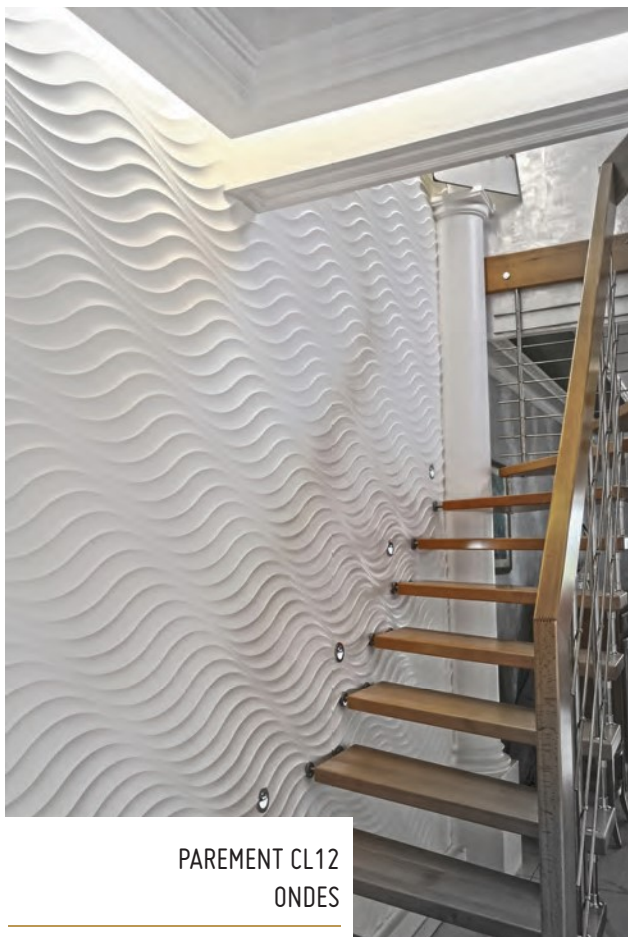

PAREMENT CL12  
ONDES

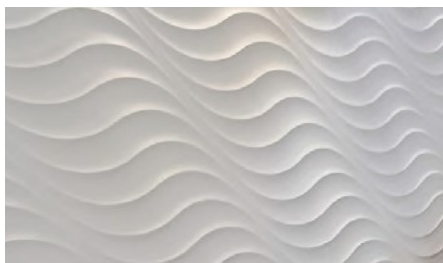
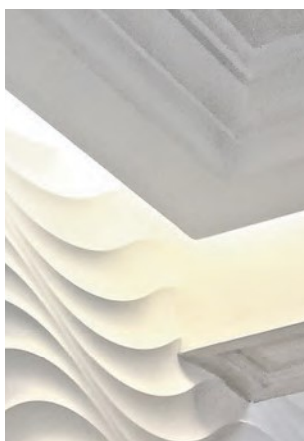



SOUBASSEMENTS MOULURÉS  
© Château Mader

# L'HABILLAGE MURAL PAR LAMBRISSAGE



SOUBASSEMENTS MOULURÉS  
© Château Mader



COMPRENDRE NOS PRODUITS DE SOUBASSEMENTS & ENCADREMENTS MURAUX AFIN DE CHOISIR CELUI QU'IL VOUS FAUT

- 1 - Lambris décaissé
- 2 - Cimaïse
- 3 - Plinthe
- 4 - Intercalaire
- 5 - Plate bande simple côté
- 6 - Plate bande double côté
- 7 - Angle de plate bande
- 8 - Tête de pilastre
- 9 - Pilastre
- 10 - Cimaïse de stylobate
- 11 - Stylobate

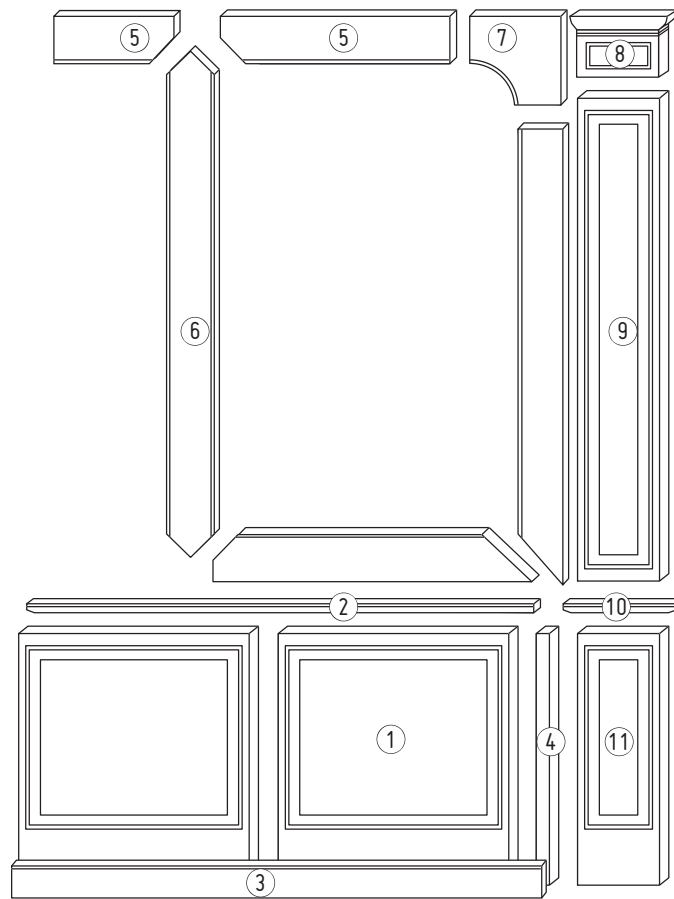

## PLATES BANDES, ANGLES DE PLATE BANDE & CIMAISES

Épaisseur : 1,5 cm

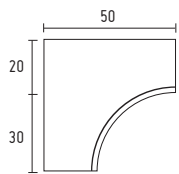

9312

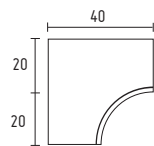

9311

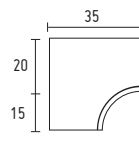

9310

Épaisseur : 1,5 cm

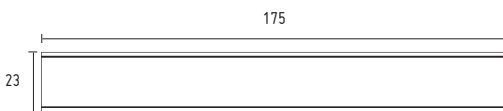

9303

Plate bande double côté

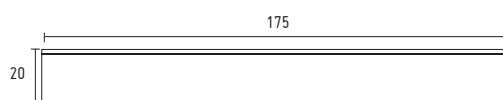

9301

Plate bande simple côté

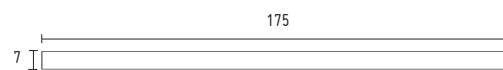

9302

Plate bande simple étroite

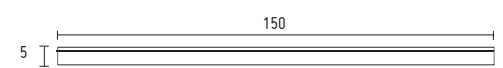

9315C

CIMAISE



# LAMBRIS DÉCAISSÉS

SOUBASSEMENT 9222



3 Hauteurs disponibles : 55, 75 et 85 cm  
 (Hauteur du lambris sans cimaise)  
 Épaisseur : 2,3 cm

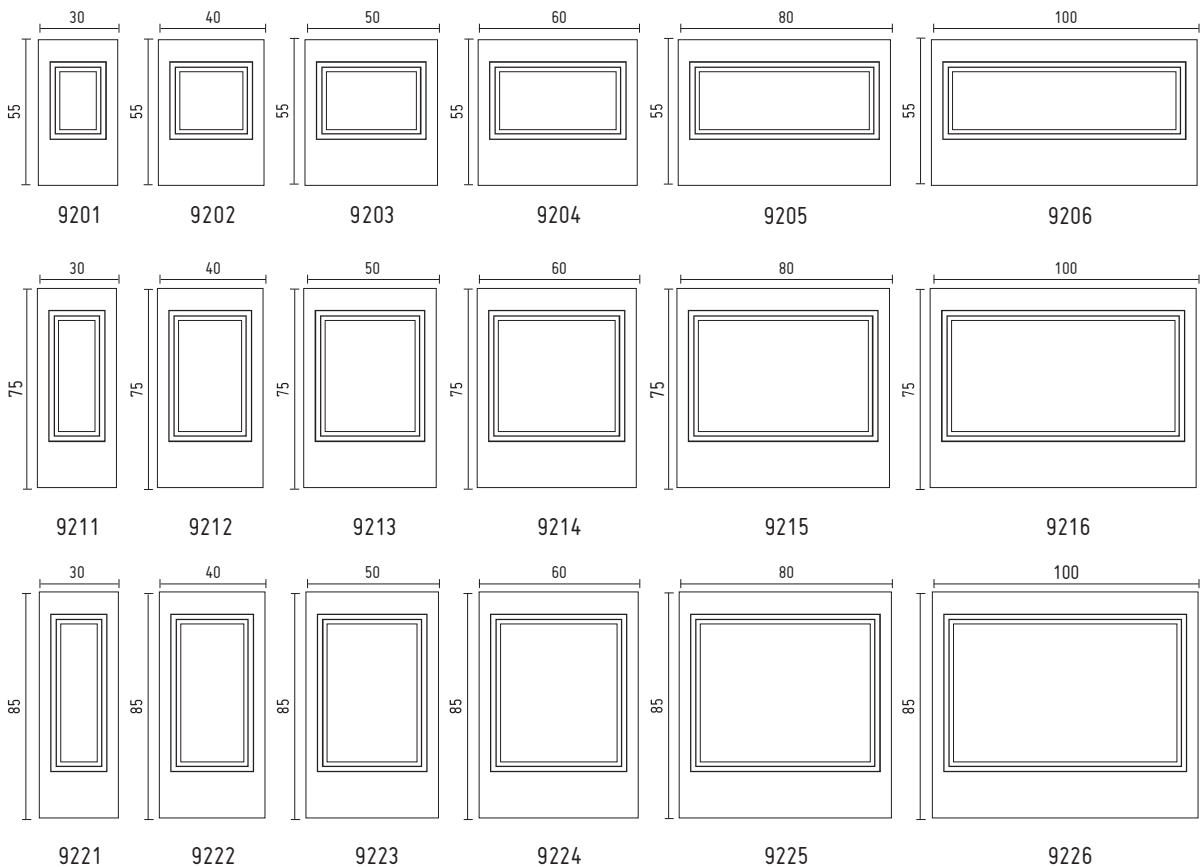



# TÊTES POUR PILASTRES

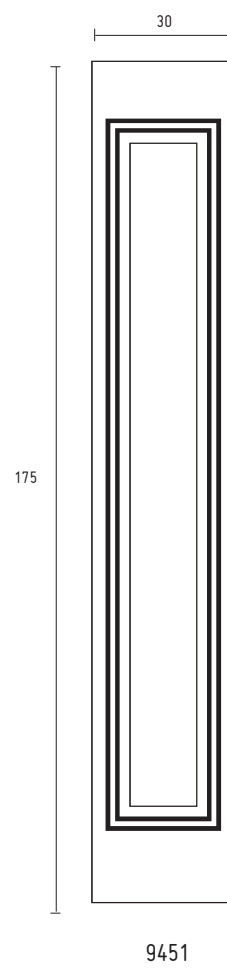
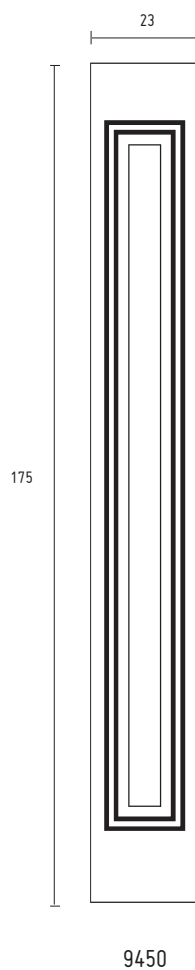
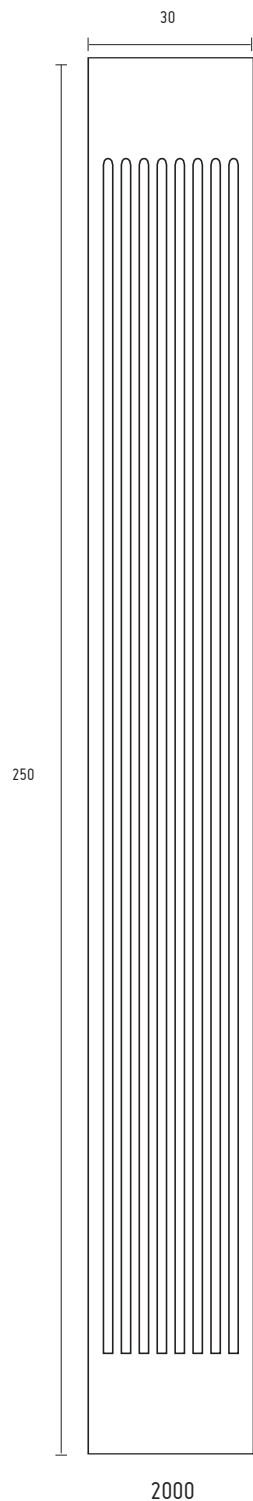
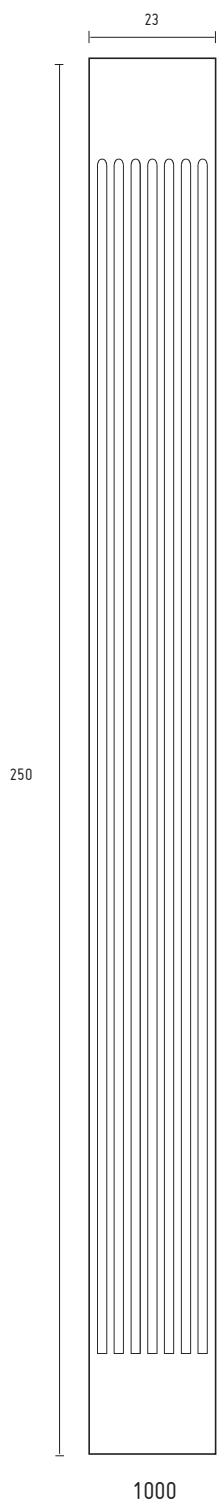
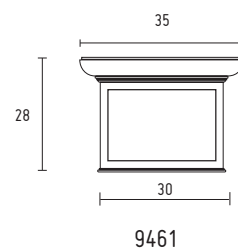
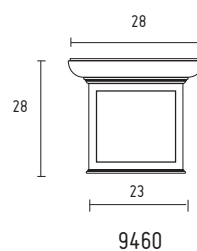
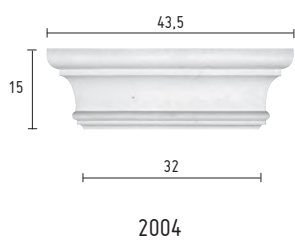
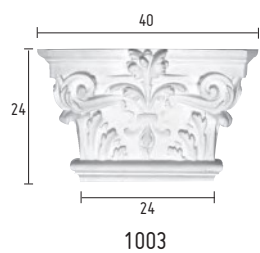

Retrouvez toutes nos têtes de pilastres, pilastres et socles à partir de la page 113 !

# INTERCALAIRES, STYLOBATES ÉLÉMENTS DE CIMAISES, PLINTHES

Épaisseur : 7 cm  
Éléments de cimaise

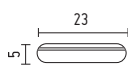

9315.23

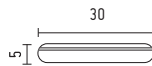

9315.30

Épaisseur : 2 cm  
Intercalaire

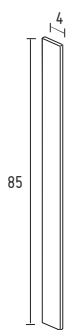

9280

Épaisseur : 4,5 cm  
Stylobates

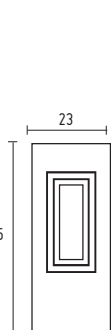

9401

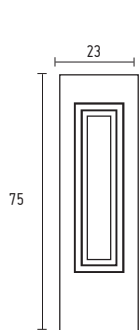

9402

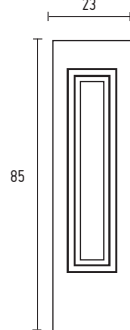

9403

Épaisseur : 4,5 cm  
Stylobates

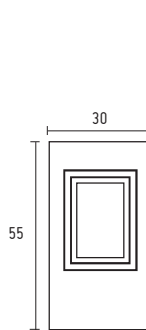

9411

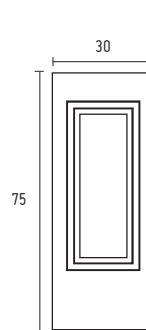

9412

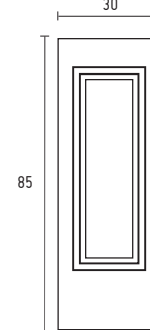

9413



Pensez à composer :  
Découvrez tous nos modèles de plinthes à la page 103  
de notre catalogue !



# NOS AUTRES SOLUTIONS POUR VOS SOUBASSEMENTS

*Une cinnaise*



*un panneau*



*une plinthe*



1140C (en 1,50 ml)



1141C (en 1,50 ml)



9315C (en 1,50 ml)



9020 - H 118 x L 70 cm



9021 - H 86 x L 70 cm



9211 - H 75 x L 30 cm



9025 - H 120 x L 32 cm

## Nos autres modèles de cinnaises



1101C (en 1,50 ml)



1103C (en 1,50 ml)



1145C (en 1,50 ml)



SDC1 (en 1,20 ml)  
Conditionnement en carton de 4 éléments



SDC2 (en 1,20 ml)  
Conditionnement en carton de 4 éléments

*Sélectionnez votre profil  
& choisissez la dimension  
de votre panneau !*

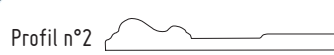

| RÉFÉRENCE<br>DES PANNEAUX |                 |       |       |
|---------------------------|-----------------|-------|-------|
| Dimensions en cm          | 80x50           | 55x50 | 20x50 |
| Profil n°1                | 9001            | 9003  | 9002  |
| Profil n°2                | 9011            | 9013  | 9012  |
| Profil n°3                | 9031<br>(83x50) | 9033  | 9032  |

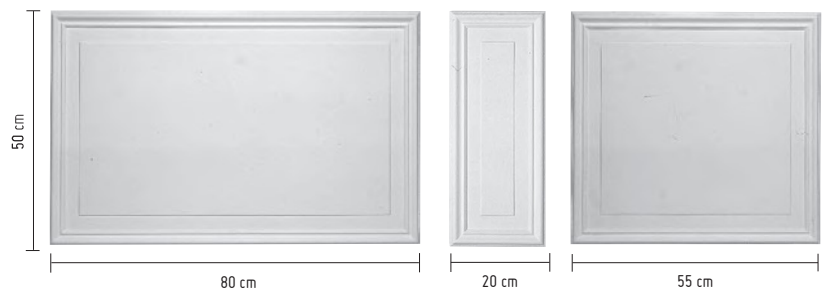

## Nos modèles de plinthes

PLIN08 (en 1,50 ml), hauteur 8 cm  
 PLIN10 (en 1,50 ml), hauteur 10 cm  
 PLIN12 (en 1,50 ml), hauteur 12 cm  
 PLIN15 (en 1,50 ml), hauteur 15 cm  
 PLIN20 (en 1,50 ml), hauteur 20,5 cm



Angles sortants :  
 PLIN10A (pour PLIN10)  
 PLIN12A (pour PLIN12)  
 PLIN15A (pour PLIN15)  
 PLINTA (pour PLINT)



PLINT (en 1,50 ml), hauteur 10 cm



PLIN08M (en 1,50 ml), hauteur 8 cm  
 PLIN10M (en 1,50 ml), hauteur 10 cm



# LES HABILLAGES DE PORTE

## LE CONTEMPORAIN

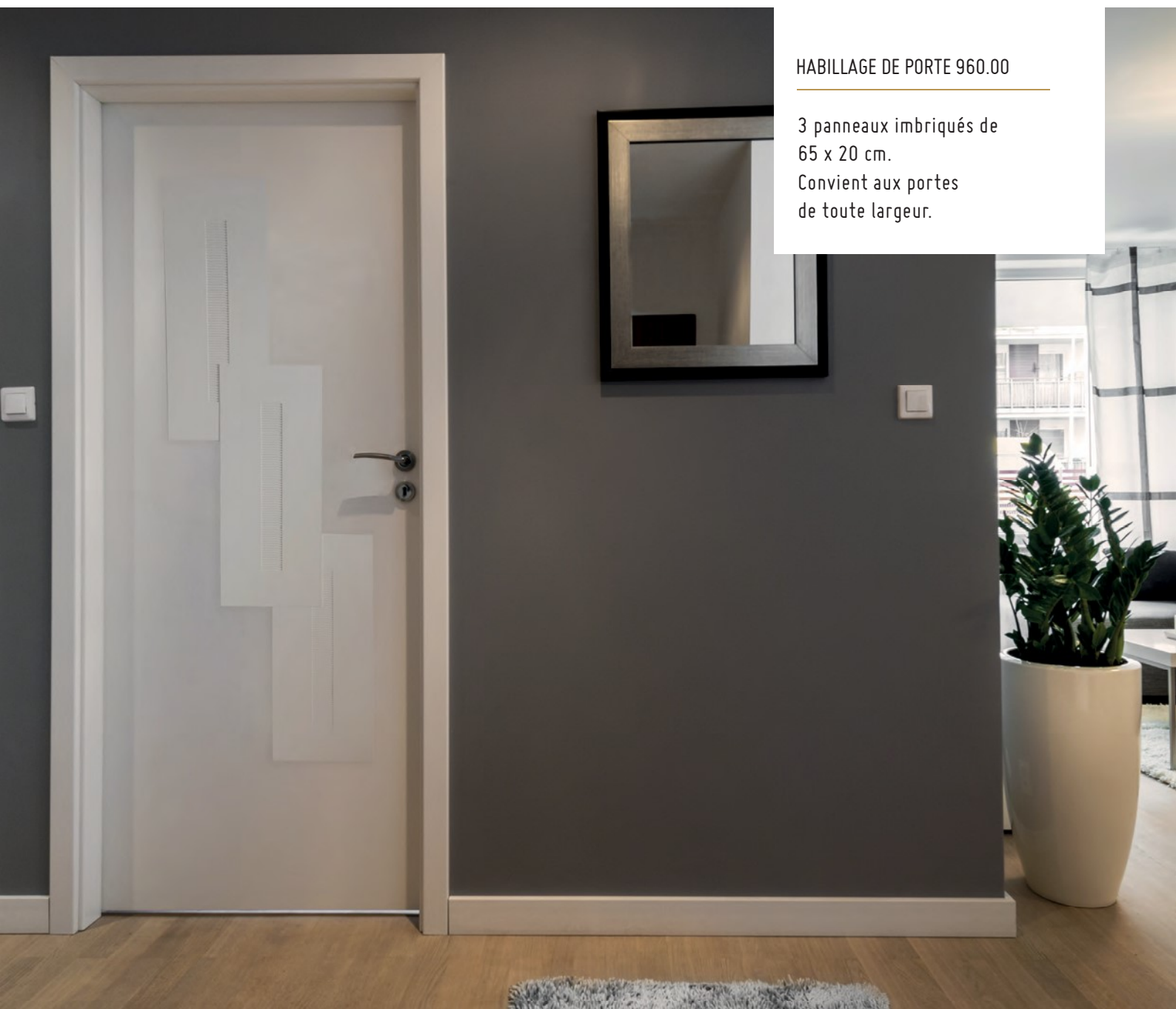

### HABILLAGE DE PORTE 960.00

3 panneaux imbriqués de 65 x 20 cm.

Convient aux portes de toute largeur.



#### Mise en oeuvre

- Poser la porte sur 2 tréteaux.
- Exécuter un tracé sur la porte pour déterminer l'emplacement exact des panneaux à coller.
- Poncer à l'aide de gros papier de verre pour éliminer les fonds de peinture et rayer au cutter pour faciliter l'accrochage.
- Sur le panneau d'habillage de porte, appliquer de la colle pour carrelage référence 0034 (en 5 kg) ou 0036 (en 1,5 kg) à l'aide d'une spatule à dents.
- Procéder au raclage des bavures, dès que la colle a commencé à faire sa prise.

La finition de ces panneaux vous évitera tout ponçage et préparations diverses avant l'application de la peinture.

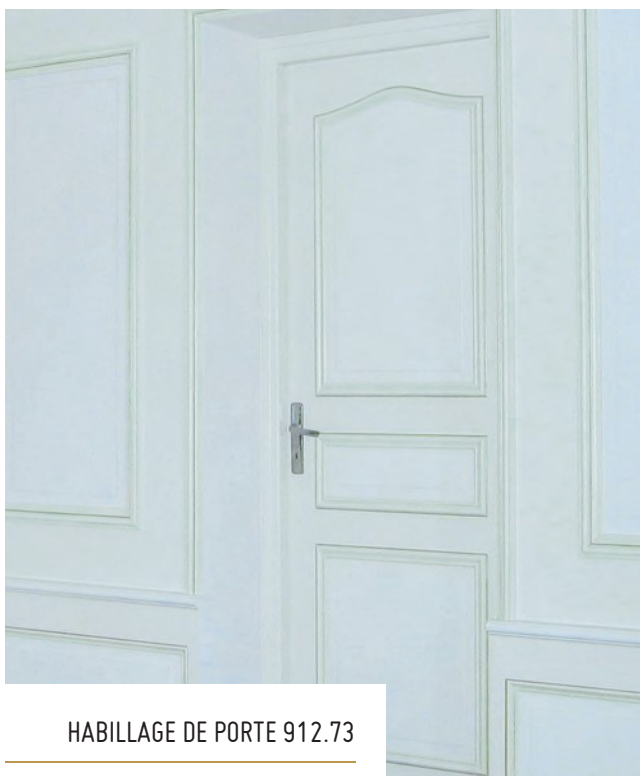

HABILLAGE DE PORTE 912.73



Habillage de porte 902.73,  
couvre joint 1108,  
fronton de Porte,  
moulure 1156.



Profil n°1



Profil n°2



Profil n°3

| RÉFÉRENCES<br>DES DIFFÉRENTS<br>MODÈLES |                    |        |        |        |        |        |        |
|---|--------------------|--------|--------|--------|--------|--------|--------|
| TYPE DE PROFIL                          | LARGEUR DES PORTES |        |        |        |        |        |        |
| Profil n°1                              | 63 cm              | 901.63 | 911.63 | 921.63 | 930.63 | 940.63 | 950.63 |
|   | 73 cm              | 901.73 | 911.73 | 921.73 | 930.73 | 940.73 | 950.73 |
|   | 83 cm              | 901.83 | 911.83 | 921.83 | 930.83 | 940.83 | 950.83 |
| Profil n°2                              | 63 cm              | 902.63 | 912.63 | 922.63 | 932.63 | 942.63 | 952.63 |
|   | 73 cm              | 902.73 | 912.73 | 922.73 | 932.73 | 942.73 | 952.73 |
|   | 83 cm              | 902.83 | 912.83 | 922.83 | 932.83 | 942.83 | 952.83 |
| Profil n°3                              | 63 cm              | 903.63 | 913.63 |        | 933.63 | 943.63 |        |
|   | 73 cm              | 903.73 | 913.73 |        | 933.73 | 943.73 |        |
|   | 83 cm              | 903.83 | 913.83 |        | 933.83 | 943.83 |        |

# LES COUVRE-JOINTS

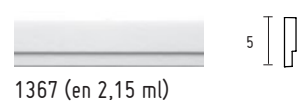
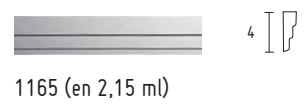
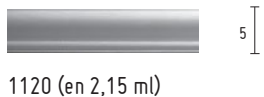
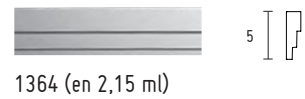
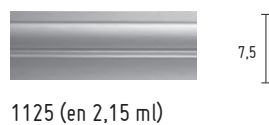
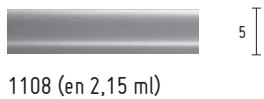

# LES TALONS DE PORTE

TAL12 :  
H 12 cm, L 6 cm, E 2 cm  
TAL14 :  
H 14 cm, L 6 cm, E 2 cm  
TAL17 :  
H 17 cm, L 6 cm, E 2 cm



TALGM  
H 17 cm, L 9 cm, E 3,5 cm  
TALSP  
H 14 cm, L 7,5 cm, E 2,2 cm

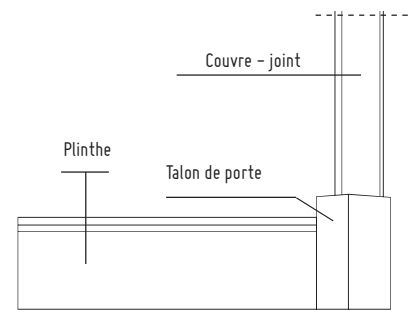

D'autres talons de portes adaptés à vos moulures sont disponibles en magasin. Renseignez-vous auprès de votre conseiller Staff Décor !

# LES FRONTONS



3900 - 101 x 31 cm



3905 - 79,5 x 42  
livré finition plâtre naturel



3902 - 99 x 36 cm



Nos frontons vous sont livrés brut de plâtre. N'hésitez pas à les personnaliser et les adapter aux couleurs de votre intérieur en les peignant !

FRONTON 3903  
© The White House, Cannes

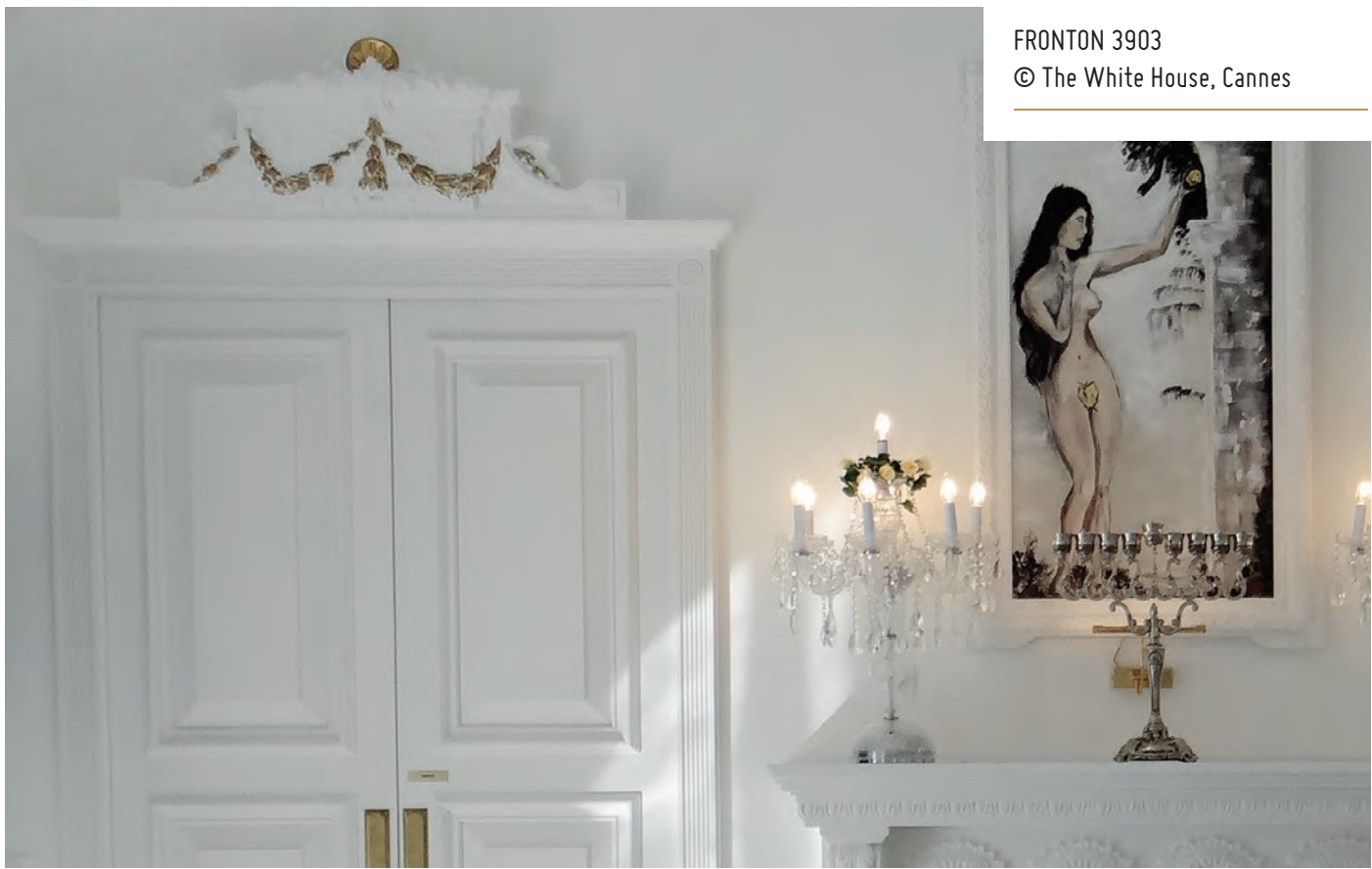

3904 - 100 x 22 cm



3901 - 112 x 30 cm



3903 - 120 x 45 cm



# LES COLONNES



**40.06**  
24 x 24 x H 11 cm  
40.60, 1/2 chapiteau



**40.07**  
24 x 24 x H 13 cm  
40.70, 1/2 chapiteau



**40.03**  
Ø 29,5 cm - H 13 cm  
40.30, 1/2 chapiteau



**40.08**  
29 x 29 x H 24 cm  
40.80, 1/2 chapiteau



**40.09**  
24 x 24 x H 8 cm  
40.90, 1/2 chapiteau



**40.01**  
46 x 46 x H 40 cm  
40.10, 1/2 chapiteau



**40.04**  
30 x 30 x H 10 cm  
40.40, 1/2 chapiteau



**40.07A**  
29 x 29 x H 13 cm  
40.70A, 1/2 chapiteau



**20.05**  
H 200 cm  
sous collerette  
Ø haut 14 cm  
Ø base / 19 cm

**20.55**  
1/2 col.  
H 205 cm

Socle :  
25 x 25 x 30 cm



**20.04**  
H 200 cm  
sous collerette  
Ø haut 14 cm  
Ø base / 19 cm

**20.54**  
1/2 col.  
H 205 cm

Socle :  
25 x 25 x 30 cm



**20.02**  
H 220 cm  
sous collerette  
Ø haut 20 cm  
Ø base / 26 cm

**20.52**  
1/2 col.  
H 220 cm

Socle :  
35 x 35 x 50 cm



## Mise en oeuvre

- Pour habiller un poteau nos colonnes sont livrées par deux 1/2 colonnes à assembler
- L'ajustement de la colonne à la hauteur désirée se fait par réduction de la hauteur du socle ou encore de son fût.

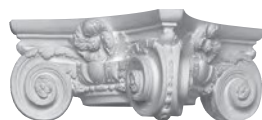

40.02  
41 x 41 x H 16,5 cm  
40.20, 1/2 chapiteau



40.01  
46 x 46 x H 40 cm  
40.10, 1/2 chapiteau



40.05  
34 x 34 x H 10 cm  
40.50, 1/2 chapiteau

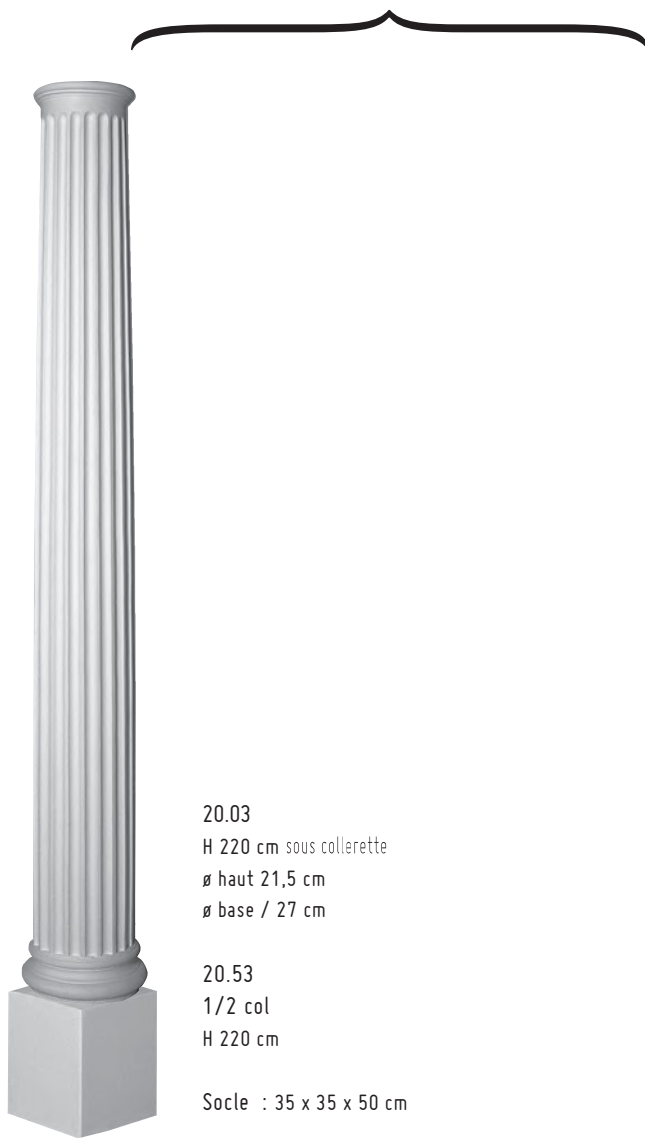

20.03  
H 220 cm sous collerette  
ø haut 21,5 cm  
ø base / 27 cm

20.53  
1/2 col  
H 220 cm

Socle : 35 x 35 x 50 cm









20.01  
H 220 cm  
ø 25 cm

20.51  
1/2 col.  
H 220 cm

Socle : 35 x 35 x 50 cm

# Composez vos colonnes !

A l'aide de notre tableau de correspondances, choisissez les éléments qui s'adapteront à votre intérieur !

|  | DIAMETRE | DIMENSIONS<br>colonne entière<br>H x L x l | LISSES     |                |   | HAUTEUR<br>(en cm) | CANNELEES  |                |            |        |            |        |
|--|----------|--|------------|----------------|---|--------------------|--|----------------|------------|--------|------------|--------|
|  |          |  | ½          | ENTIERE        |   |                    | ½  | ENTIERE        |            |        |            |        |
| <b>CHAPITEAUX</b><br>                 | Ø 15     | 11x24x24                                   | 40.60      | 40.06          | <b>CHAPITEAUX</b><br>      |                    | 40.60  | 40.06          |            |        |            |        |
|  | Ø 20     | 10x30x30                                   | 40.40      | 40.04          |   |                    | 40.40  | 40.04          |            |        |            |        |
|  | Ø 25     | 10x34x34                                   | 40.50      | 40.05          |   |                    | 40.50  | 40.05          |            |        |            |        |
|  | Ø 30     | 11,5x40x40                                 | 41.51      | 41.01          |   |                    | 41.51  | 41.01          |            |        |            |        |
|  | Ø 35     | 12,5x46x46                                 | 41.55      | Nous consulter |   |                    | 41.55  | Nous consulter |            |        |            |        |
|  | Ø 40     | 11x52x52                                   | 41.52      | 41.02          |   |                    | 41.52  | 41.02          |            |        |            |        |
|  | Ø 50     | 13x63x63                                   | 41.53      | 41.03          |   |                    | 41.53  | 41.03          |            |        |            |        |
| <b>FÔTS LISSES</b><br>              | Ø 10     | 250  | 20.58      | 20.08          | <b>FÔTS CANNELES</b><br> | 250                | 20.56  | 20.06          |            |        |            |        |
|  | Ø 15     | 300  | 30.52      | 30.02          |   | 250                | 31.51  | 31.01          |            |        |            |        |
|  | Ø 20     | 300  | 30.53      | 30.03          |   | 300                | 31.52  | 31.02          |            |        |            |        |
|  | Ø 25     | 300  | 30.54      | 30.04          |   | 300                | 31.53  | 31.03          |            |        |            |        |
|  | Ø 30     | 300  | 30.55      | 30.05          |   | 300                | 31.54  | 31.04          |            |        |            |        |
|  | Ø 35     | 300  | 30.56      | 30.06          |   | 300                | Nous consulter   | Nous consulter |            |        |            |        |
|  | Ø 40     | 300  | 30.57      | 30.07          |   | 300                | -  | -              |            |        |            |        |
|  | Ø 50     | 300  | 30.58      | 30.08          |   | 300                | -  | -              |            |        |            |        |
|  | Ø 60     | 300  | 30.59      | 30.09          |   | 300                | -  | -              |            |        |            |        |
|  | Ø 70     | 300  | 30.60      | 30.10          |   | 300                | -  | -              |            |        |            |        |
|  | Ø 75     | 300  | 30.61      | 30.11          |   | 300                | -  | -              |            |        |            |        |
|  | Ø 80     | 300  | 30.62      | 30.12          |   | 300                | -  | -              |            |        |            |        |
|  | Ø 90     | 300  | 30.63      | -              |   | 300                | -  | -              |            |        |            |        |
| <b>SOCLES &amp; COLLERETTES</b><br> |          | DIM. ENTIER                                | COLLERETTE | SOCLE          | COLLERETTE  | SOCLE              | <b>SOCLES &amp; COLLERETTES</b><br> | Hauteur        | COLLERETTE | SOCLE  | COLLERETTE | SOCLE  |
|  | Ø 10     | 14,5x14x14                                 | 20.56B     | 20.56S         | 20.06B  | 20.06S             |  | 14,5           | 20.56B     | 20.56S | 20.06B     | 20.06S |
|  | Ø 15     | 39x25x25                                   | 45.51      |                | 45.01   |                    |  | 39             | 45.51      |        | 45.01      |        |
|  | Ø 20     | 31x32x32                                   | 45.52      |                | 45.02   |                    |  | 31             | 45.52      |        | 45.02      |        |
|  | Ø 25     | 61x35x35                                   | 45.53      |                | 45.03   |                    |  | 61             | 45.53      |        | 45.03      |        |
|  | Ø 30     | 41x42x42                                   | 45.54      |                | 45.04   |                    |  | 41             | 45.54      |        | 45.04      |        |
|  | Ø 35     | Nous consulter                             | 45.55      |                | 45.05   |                    |  | Nous consulter | 45.55      |        | 45.05      |        |
|  | Ø 40     |  | 45.56      |                | 45.06   |                    |  |                | 45.56      |        | 45.06      |        |
| Ø 50   | 45.57    |  |            | 45.07          |   | 45.57              |  |                | 45.07      |        |            |        |

Dimensions en cm



Les socles peuvent être coupés en hauteur.



FÛT 20.02  
CHAPITEAU 40.01  
PAGE 108

20.57HD et 20.57HG  
3/4 Colerette haute droite ou gauche  
20.56H  
H 6,5 cm / ø 14 cm  
1/2 Colerette haute

*Détail de la colerette*

20.06H  
H 6,5 cm / ø 14 cm  
colerette haute

20.08  
Colonne lisse  
H 250 cm  
ø 10 cm  
Sans colerette ni socle

20.06  
Colonne cannelée  
H 250 cm  
ø 10 cm  
Sans colerette ni socle

20.59  
3/4 de colonne lisse  
H 250 cm  
ø 10 cm  
Sans colerette ni socle

20.57  
3/4 de colonne cannelée  
H 250 cm  
ø 10 cm  
Sans colerette ni socle

20.58  
1/2 colonne lisse  
H 250 cm  
ø 10 cm  
Sans colerette ni socle

20.56  
1/2 colonne cannelée  
H 250 cm  
ø 10 cm  
Sans colerette ni socle

*Socle & colerette basse*

20.06B / H 4,5 cm / ø 13 cm  
Colerette basse

20.06S / 14 x 14 x 10 cm  
Socle

20.57BD  
3/4 Colerette basse droite

20.57SD  
3/4 Socle droit

20.57BG  
3/4 Colerette basse gauche

20.57SG  
3/4 Socle gauche

20.56B / H 4,5 cm / ø 13 cm  
1/2 Colerette basse

20.56S / 14 x 7 x 10 cm  
1/2 Socle



**Mémo mise en oeuvre**

Attention : Les socles et colerettes basses sont dissociés.

Aussi pour toutes vos commandes, veuillez à bien sélectionner toutes les références nécessaires.



2001  
H 8 x L 40 x E 6 cm



2004  
H 15 x L 43,5 x E 10 cm



2000  
H 250 cm x L 30 cm x E 3 cm



2020  
H 244 cm x L 30 cm x E 2,5 cm



2005  
H 30 cm x L 39 cm x E 7 cm



PILASTRE 2020

# LES PILASTRES



1001  
H 8 x L 33,5 x E 6 cm



1002  
H 34 x L 36 x E 10 cm



1003  
H 24 x L 40 x E 11 cm



1004  
H 15 x L 37 x E 10 cm



1055  
H 28,5 x L 34,5 x E 10 cm



0999  
H 17 x L 41 x E 12 cm



1000  
H 250 cm x L 23 cm x E 3 cm



1025  
H 250 cm x L 23 cm x E 3 cm



Notre fleur de  
trumeau existe  
aussi seule :  
3906



1050  
H 250 cm x L 23 cm x E 3,5 cm



1005  
Pour pilastres 1000, 1025, 1050 et 2031  
H 30 cm x L 31 cm x E 7 cm



0952  
H 15,5 x L 26 x E 6,6 cm



0951  
H 8 x L 29,5 x E 6 cm

*Personnalisez vos pilastres avec nos ornements centrales !*



2030M : Rectangle central pour pilastre 2030



2031C : Cercle central pour pilastre 2031



2031M : Rectangle central pour pilastre 2031

*également compatible*



Ce pilastre existe également en 40 cm de largeur pour une hauteur de 250 cm sous la référence 3000.



0950  
H 250 cm x L 19 cm x E 3,5 cm

2030  
H 170 cm x L 17 cm x E 1,5 cm



0955  
H 24,5 cm x L 24,5 cm x E 6 cm

Existe aussi  
2031  
H 170 cm x L 23 cm x E 1,5 cm





0761  
H 9 x L 12 x E 4 cm



0801  
H 8 x L 22,5 x E 4,5 cm



0802  
H 18 x L 22,5 x E 6 cm



0803  
H 9 x L 17 x E 4 cm



0762  
H 4,5 x L 13 x E 4 cm



0804  
H 15 x L 26 x E 9 cm



0806  
H 5,5 x L 19 x E 5 cm



0760  
H 250 cm x L 7 cm x E 1,5 cm



Autre modèle de pilastre  
cannelé Réf. 0780  
(H 250 cm, L 10 cm, E 1,5 cm)  
avec têtes 0781 ou 0782  
et socle 0785.



0800  
H 250 cm x L 12 cm x E 2 cm



0765  
H 17 cm x L 9,5 cm x E 3 cm



0805  
H 17,5 cm x L 14,5 cm x E 3 cm

# LES BALUSTRES



0901

H 9,5 x L 22 x E 4,5 cm



0902

H 14,5 x L 26 x E 7 cm



0903

H 15,5 x L 31 x E 9 cm



0904

H 8 x L 26 x E 5 cm



0900

H 250 cm x L 17 cm x E 2,5 cm



0905

H 21 cm x L 20 cm x E 4 cm

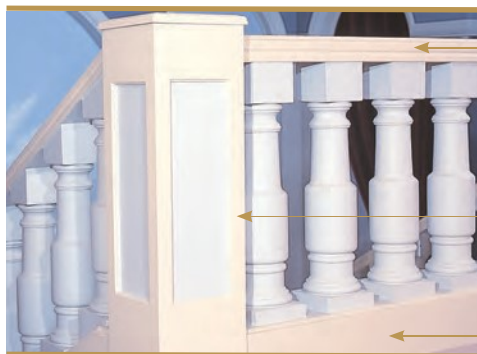

7004  
Main courante  
L 14,5 x 7 cm  
(en 2 ml)

7006  
Poteau  
25 x 25 x H 95 cm

7005  
Socle  
L 23,5 x 26 cm  
(en 2 ml)



Balustre 1

7001

H 60 cm

Base

15,5 x 15,5 cm



Balustre 3

7003

H 80 cm

Base

16,5 x 16,5 cm



Balustre 2

7002

H 60 cm

Base

15,5 x 15,5 cm

MEUBLE MODULOSTAFF  
PAGE 124

CACHE RADIATEUR  
PAGE 148

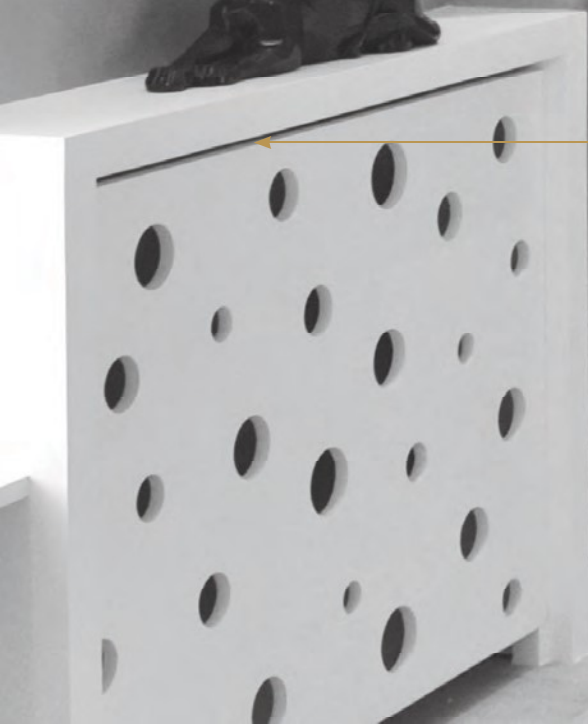

CORNICHE D575  
PAGE 19

PASSAGE ÉCLAIRANT  
PAGE 143

PAREMENT CAPITON  
7072  
PAGE 82

# LES AGENCEMENTS

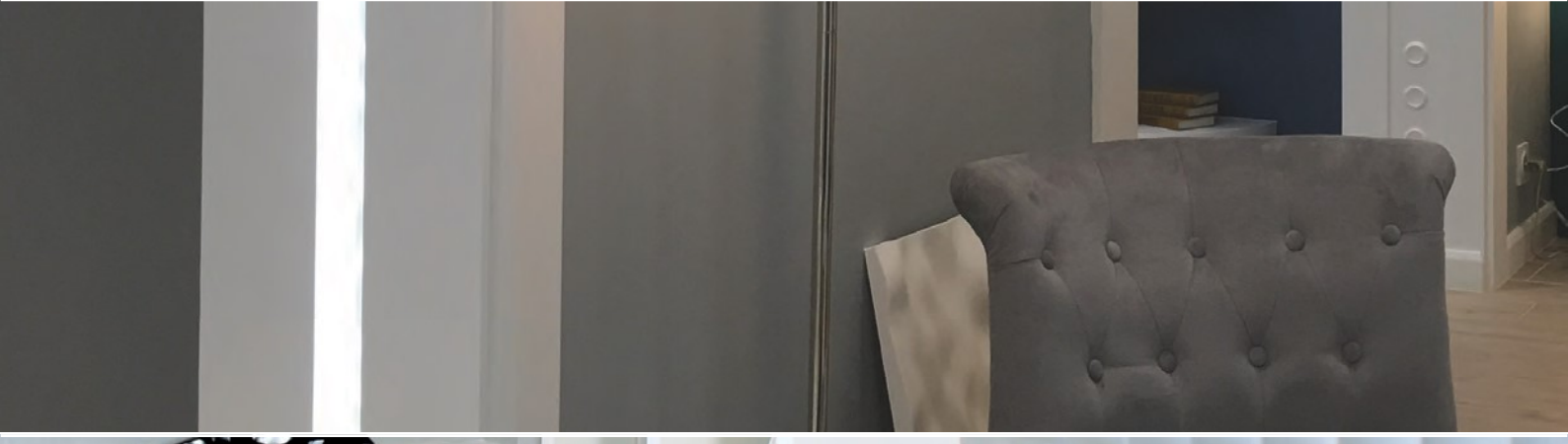



## LE MODULOSTAFF & LES NICHES

122

ÉLÉMENTS CREUX POUR MODULO

124

ÉLÉMENTS D'ANGLES EN QUART DE ROND POUR MODULO

125

ÉLÉMENTS PLEINS POUR MODULO

127

LES NICHES CONTEMPORAINES

128

LES NICHES CLASSIQUES

129

LES NICHES GRANDES DIMENSIONS

129



## LES TÊTES DE LIT

130

TÊTE DE LIT OCÉAN

130

TÊTE DE LIT CAPITONS

130

TÊTE DE LIT SAHARA

131



## LES MEUBLES EN STAFF

132

MEUBLES TV

132

BIBLIOTHÈQUES

133

MEUBLES BIBLIOTHÈQUES

134

MEUBLES ET DÉCORS DE SALLE DE BAIN

136



## LES PASSAGES ET MEUBLES DE PASSAGE

138

LES PASSAGES CLASSIQUES

140

LES VOUTES

141

LES PASSAGES CONTEMPORAINS

142

LES PASSAGES ÉCLAIRANTS

143

LES MEUBLES DE PASSAGE

144



## LES CACHE RADIATEURS

146

LES CONTEMPORAINS

148

LES CLASSIQUES

149



MODULO MOD23  
PAGE 124

# LE MODULOSTAFF & LES NICHE

NICHE  
PAGE 128

---







Simplifiez-vous la vie !

Faites passer vos gaines techniques dans les éléments creux pour l'alimentation de vos spots et LEDS ou votre matériel HIFI !

## MODULEZ EN FONCTION DE VOS BESOINS !

Associez nos accessoires à nos éléments creux et obtenez un meuble sur-mesure à votre image !

## ÉLÉMENTS CREUX POUR MODULO

| Montants verticaux (1) |         |            |           |
|------------------------|---------|------------|-----------|
| Réf.                   | Hauteur | Profondeur | Épaisseur |
| MOD23                  | 250 cm  | 36 cm      | 5 cm      |
| MOD24                  | 250 cm  | 36 cm      | 7 cm      |
| MOD25*                 | 250 cm  | 36 cm      | 7 cm      |

\* 4 faces lisses

| Éléments horizontaux (étagères) (2) |          |            |           |
|-------------------------------------|----------|------------|-----------|
| Réf.                                | Longueur | Profondeur | Épaisseur |
| MOE45                               | 37,5 cm  | 35,5 cm    | 7 cm      |
| MOE60                               | 52,5 cm  | 35,5 cm    | 7 cm      |
| MOE90                               | 82,5 cm  | 35,5 cm    | 7 cm      |
| MOE120                              | 112,5 cm | 35,5 cm    | 7 cm      |

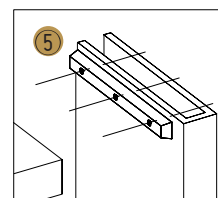
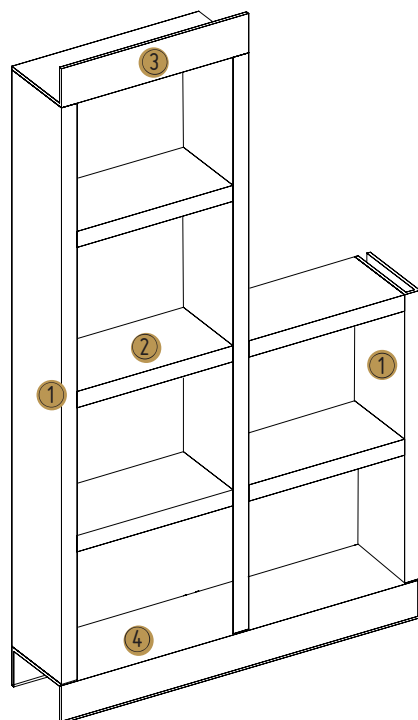

## ACCESSOIRES OPTIONNELS

Casquette (3) MODC : hauteur : 17 cm, profondeur 36 cm en élément de 2 ml.

Socle (4) MODS : hauteur : 17 cm, profondeur 36 cm en élément de 2 ml.

Glissières (5) pour la fixation des étagères (vendues par 10 unités), pré-perçées, à visser et à coller à l'enduit.

MOD06 (pour MOD24 et MOD25)

MOD05 (pour MOD23)

# ÉLÉMENTS D'ANGLE EN QUART DE ROND POUR MODULO

**Mise en oeuvre :**



L'étagère MOA24, le socle MOAS et la casquette MOAC permettent de créer des angles arrondis dans les compositions modulostaff de la gamme MOD24. De même rayon que la profondeur des éléments MOD24, leur pose sur glissières suit le même principe que pour les éléments droits.

ETAGERE (MOA23)

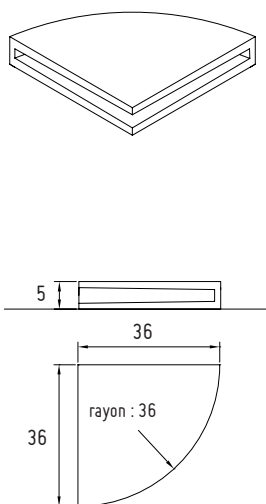

ETAGERE (MOA24)

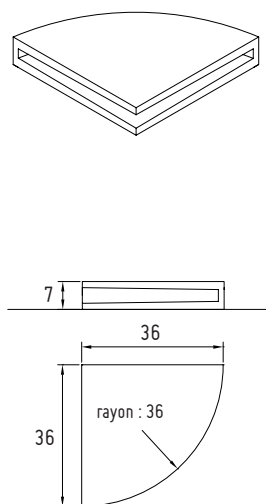

SOCLE (MOAS)

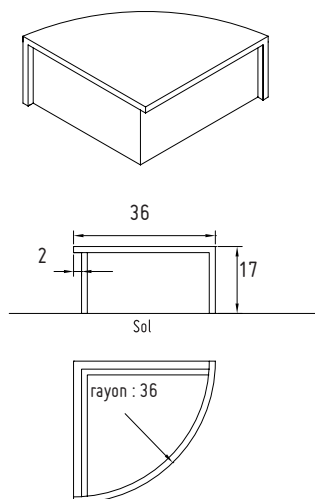

CASQUETTE (MOAC)

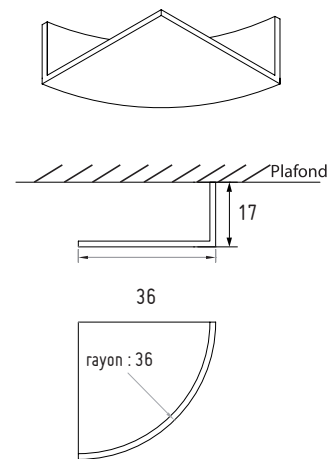

MODULO ARRONDI



Nous vous proposons des solutions de plinthes cintrées pour vos modulos: MOAPLIN10, MOAPLIN10M, MOAPLINT

## COMMENT COMPOSER ?

Deux exemples pour tout comprendre et surtout s'inspirer !

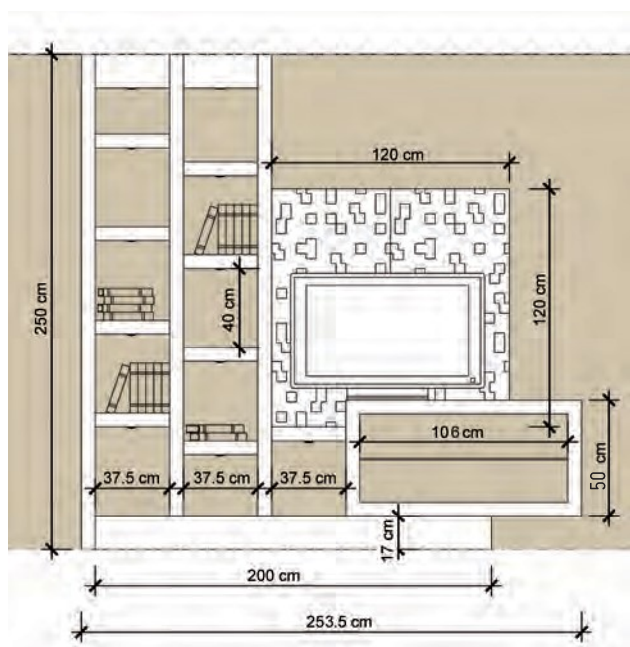

Composition pour TV et bibliothèque réalisée à partir de la gamme Modulostaff MOD24.



Réalisée à partir de la gamme Modulostaff MOD24, la composition "Quinconce" offre une solution de rangement contemporaine et rythmée. Accentuez le jeu de rythme grâce à l'alternance des éclairages.

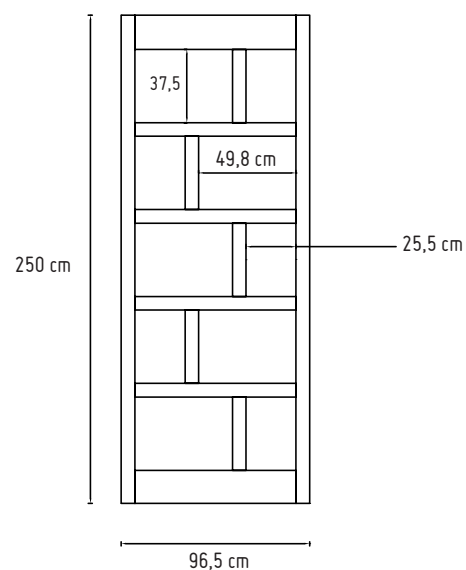

# ÉLÉMENTS PLEINS POUR MODULO

Voici un concept de composants en staff en 5 cm d'épaisseur pour réaliser vos étagères.  
Tous les éléments sont étudiés pour vous faciliter la pose.

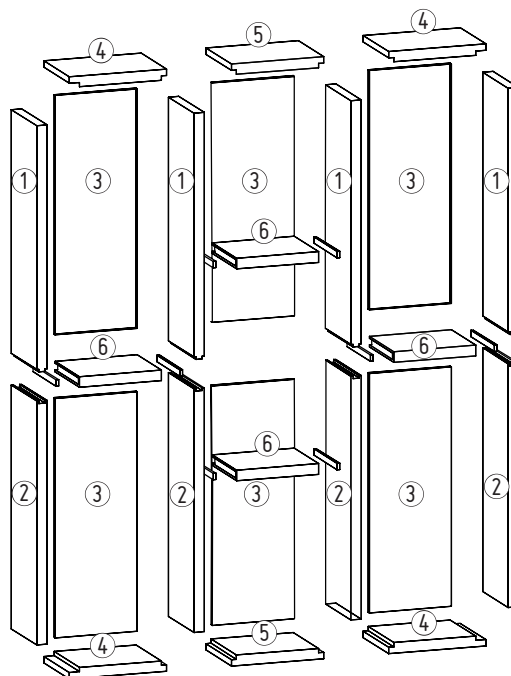
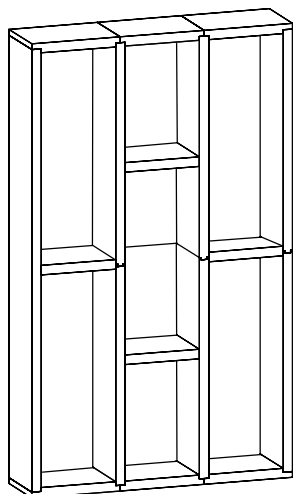

- 1 - M05-H115 : Montant (partie haute) 115 x 35 x 5 cm
- 2 - M05-B115 : Montant (partie basse) 115 x 35 x 5 cm
- 3 - M05-F0398 : Fond de meuble 111 x 39.8 x 1.5 cm
- 4 - M05-245 : Socle et/ou Casquette «Latéral» 47,3 x 35 x 5 cm
- 5 - M05-242 : Socle et/ou Casquette «Central» 44,8 x 35 x 5 cm
- 6 - M05-ET398 : Etagère 39,8 x 33,5 x 5 cm
- M05-545 : Socle / Casquette 50 x 35 x 5 cm (dans le cas d'un agencement avec une seule niche)
- MOD05 : glissières pour fixation des étagères (vendues par 10 unités)



# LES NICHES CONTEMPORAINES



0714 / 40 cm x 20 cm x P 20 cm  
0734 / 50 cm x 25 cm x P 20 cm  
0744 / 60 cm x 30 cm x P 20 cm

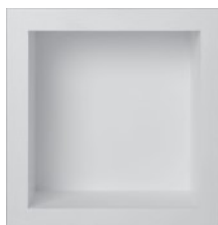

0724 / 40 cm x 40 cm x P 20 cm



0726 / Ø 40 cm x P 20 cm

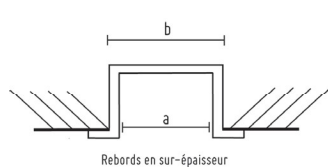

Niche à rebord



*OU*

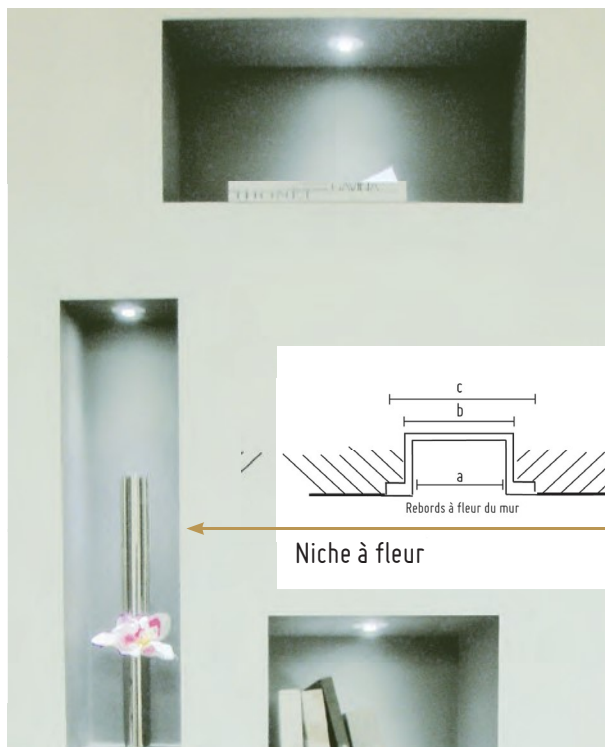

Niche à fleur

| NICHES RECTANGULAIRES ET CARRÉES |                      |         |            |                                      |         |            |                                 |         |            |
|----------------------------------|----------------------|---------|------------|--------------------------------------|---------|------------|---------------------------------|---------|------------|
| Réf.                             | Côtés intérieurs (a) |         |            | Côtés extérieures d'encastrement (b) |         |            | Côtés extérieures hors tout (c) |         |            |
|                                  | Hauteur              | Largeur | Profondeur | Hauteur                              | Largeur | Profondeur | Hauteur                         | Largeur | Profondeur |
| 0714                             | 400                  | 200     | 200        | 430                                  | 230     | 215        | 500                             | 300     | 235        |
| 0724                             | 400                  | 400     | 200        | 430                                  | 430     | 215        | 500                             | 500     | 235        |
| 0734                             | 500                  | 250     | 200        | 530                                  | 280     | 215        | 600                             | 350     | 235        |
| 0744                             | 600                  | 300     | 200        | 630                                  | 330     | 215        | 700                             | 400     | 235        |

Cotation en mm

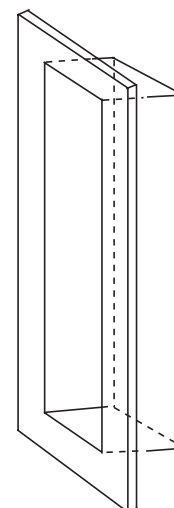

# LES NICHES CLASSIQUES «CUL DE FOUR»

| NICHES STANDARD |                      |         |            |                                     |         |            |
|-----------------|----------------------|---------|------------|-------------------------------------|---------|------------|
| Réf.            | Côtés intérieurs (a) |         |            | Côtés extérieurs d'encastrement (b) |         |            |
|                 | Hauteur              | Largeur | Profondeur | Hauteur                             | Largeur | Profondeur |
| 0710            | 300                  | 150     | 75         | 320                                 | 170     | 85         |
| 0712            | 400                  | 200     | 100        | 420                                 | 220     | 110        |
| 0732            | 500                  | 250     | 125        | 520                                 | 270     | 135        |
| 0742            | 600                  | 300     | 150        | 620                                 | 320     | 160        |

Cotation en mm

| NICHES MODULABLES EN HAUTEUR |         |            |
|------------------------------|---------|------------|
| Côtés intérieurs (a)         |         |            |
| Hauteur                      | Largeur | Profondeur |
| 1020                         | 400     | 200        |
| 1750                         | 500     | 250        |
| 1800                         | 600     | 300        |
| 1450                         | 700     | 350        |
| 2000                         | 800     | 400        |
| 2000                         | 900     | 450        |
| 2000                         | 1000    | 500        |

Cotation en mm

Toutes ces niches sont modulables en hauteur (fabrication spéciale sur devis). Pour déterminer les côtés d'encastrement ajoutez environ 30 ou 40 mm.

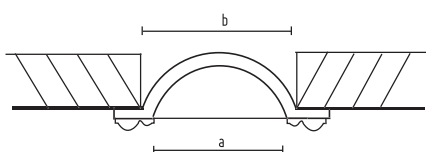

NICHE  
CUL DE FOUR

# LES NICHES GRANDES DIMENSIONS

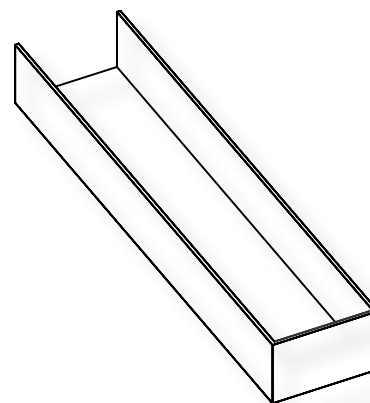
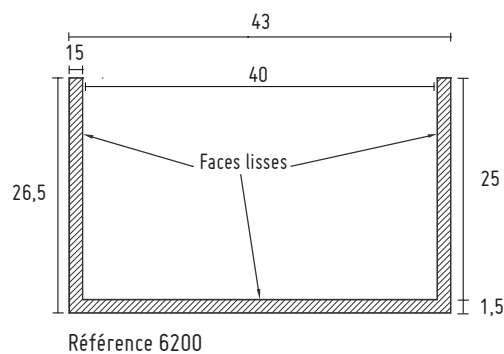
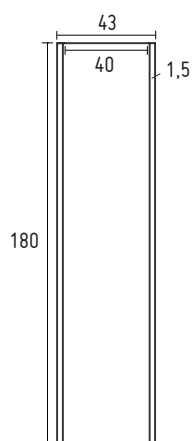

## TÊTE DE LIT OCEAN

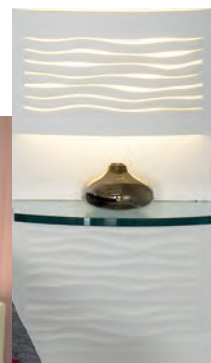

Deux largeurs standards de la partie centrale sont proposées :

- 160 cm (conseillée pour un lit de 140 cm) : T.OCEAN160
- 180 cm (conseillée pour un lit de 160 cm) : T.OCEAN180

Finition en plâtre naturel, prêt à peindre.

Pose par collage à l'enduit cellulosique.

Autres dimensions sur devis. Luminaires et ampoules inclus.

## TÊTE DE LIT CAPITONS

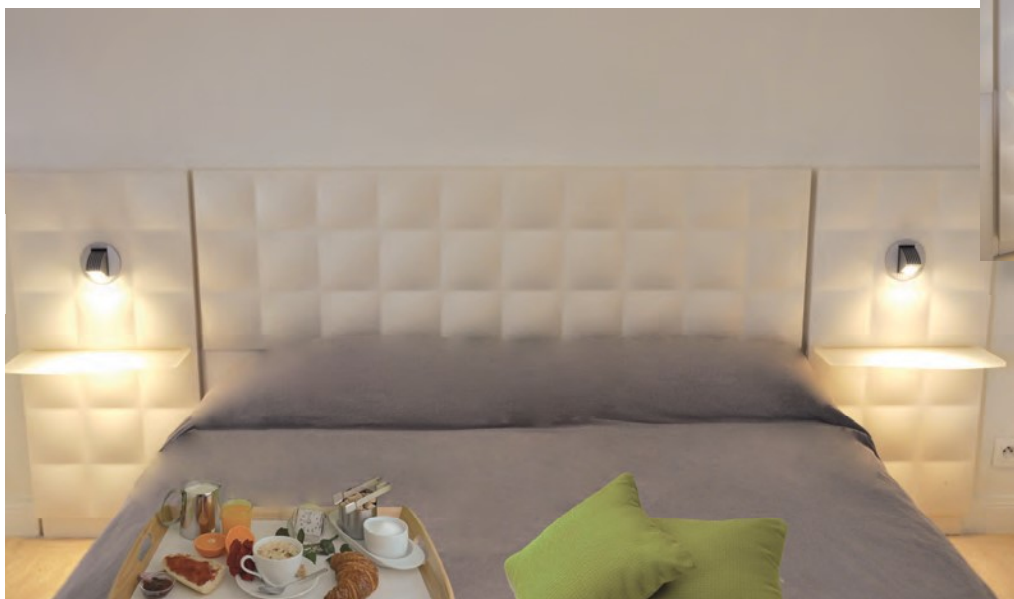

Deux largeurs standards de la partie centrale sont proposées :

- 165 cm (conseillée pour un lit de 140 cm) : T.CAPITON165
- 180 cm (conseillée pour un lit de 160 cm) : T.CAPITON180

Finition en plâtre naturel, prêt à peindre.

Pose par collage à l'enduit cellulosique.

Autres dimensions sur devis.

2 étagères en verre acrylique incluses.

Luminaires et ampoules non inclus.

# TÊTE DE LIT SAHARA

## Dimensions

Trois largeurs standards de la partie centrale sont proposées :

- 240 cm (conseillée pour lit de 140 cm) : T.SAHARA140
- 260 cm (conseillée pour lit de 160 cm) : T.SAHARA160
- 280 cm (conseillée pour lit de 180 cm) : T.SAHARA180

> Hauteur : 130 cm

> Profondeur : 8 cm (hors chevets)

## Equipement

- > 3 éléments en staff
- > Ruban LED blanc chaud ou blanc froid
- > Alimentation A.OT20/24
- > 2 rails de 2ml AA-R1707 et déflecteur opaque.

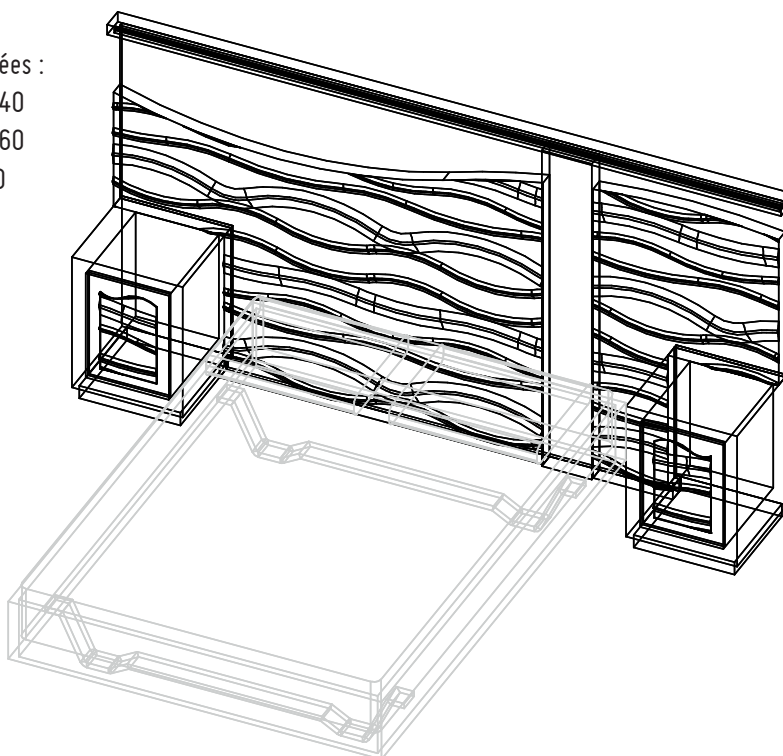

## Option chevet :

> CHEVET1 (chevet avec étagère en verre),

Profondeur totale 28,5 cm

> CHEVET2D (chevet avec porte droite),

Profondeur totale 28,5 cm

> CHEVET2G (chevet avec porte gauche),

Profondeur totale 28,5 cm

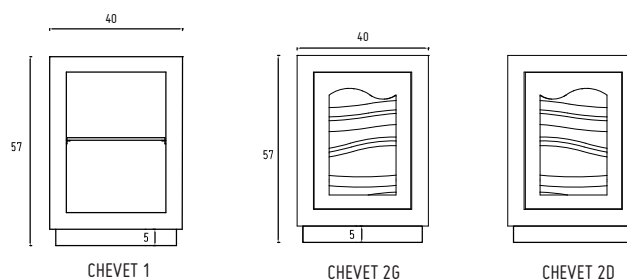

Lorsque l'option chevet est demandée, les réservations nécessaires à la pose sont créées en atelier.





## MEUBLES TV CONTEMPORAINS

Le Meuble TV contemporain est composé de deux éléments. L'élément supérieur est posé sur celui du dessous en fonction de l'écartement souhaité.

Nous proposons 4 dimensions d'étagères en verre :

44,5 cm, réf. 22160.445

54,5 cm, réf. 22160.545

60,5 cm, réf. 22160.605

67,5 cm, réf. 22160.675

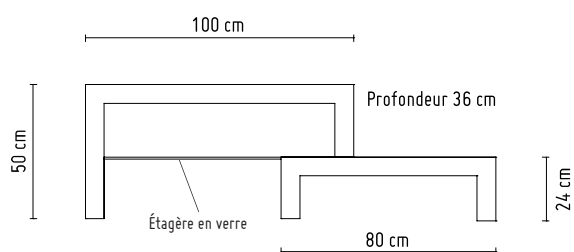

Meuble TV de style contemporain composé de quatre éléments en staff pré-monté (3 niches et un socle) à assembler par collage. Finition des éléments : plâtre naturel prêt à peindre.



Mise en oeuvre :  
Assemblage par simple collage.

# MEUBLES TV CLASSIQUES

| MEUBLES TÉLÉ                 |                             |        |                             |        |                             |        |                             |        |  |
|------------------------------|-----------------------------|--------|-----------------------------|--------|-----------------------------|--------|-----------------------------|--------|--|
|                              | 1 Niche + TV                |        | TV + 1 Niche                |        | 1 Niche + TV + 1 Niche      |        | 2 Niches + TV + 2 Niches    |        |  |
| Dimensions plateau en cm     | 191 x 44,5<br>avancée TV 64 |        | 191 x 44,5<br>avancée TV 64 |        | 248 x 44,5<br>avancée TV 64 |        | 362 x 44,5<br>avancée TV 64 |        |  |
| Hauteur meuble complet       | 248*                        |        | 248*                        |        | 248*                        |        | 248*                        |        |  |
| Référence colonnes cannelées | 5001                        |        | 5002                        |        | 5003                        |        | 5004                        |        |  |
| Référence colonnes lisses    | 5011                        |        | 5012                        |        | 5013                        |        | 5014                        |        |  |
| Option accolée à un mur **   | Gauche                      | Droit  | Gauche                      | Droit  | Gauche                      | Droit  | Gauche                      | Droit  |  |
| Référence colonnes cannelées | 5021 G                      | 5021 D | 5022 G                      | 5022 D | 5023 G                      | 5023 D | 5024 G                      | 5024 D |  |
| Référence colonnes lisses    | 5031 G                      | 5031 D | 5032 G                      | 5032 D | 5033 G                      | 5033 D | 5034 G                      | 5034 D |  |

\* Possibilité d'adapter le meuble pour des hauteurs jusqu'à 300 cm (fabrication spéciale sur devis). Possibilité d'augmenter le nombre de niches du meuble TV (niche standard 57 x 44,5 cm). Les étagères en verre et les spots sont fournis avec les meubles. Étagères en verre : une par niche partie basse, trois par niche partie haute, une par niche TV. Spots : un par niche, deux par niche TV.

\*\* Le côté droit ou gauche accolé au mur est déterminé en regardant le meuble de face.

# LES BIBLIOTHÈQUES

Les bibliothèques sont composées de une ou plusieurs niches en staff de dimensions standards, livrées en kit, dont les éléments sont ajustés, collés à l'enduit lors du montage et prêts à peindre.

STAFF DÉCOR propose deux modèles de niches :

- Niche décorée par des colonnes cannelées
- Niche décorée par des pilastres cannelés

Une fois peintes, les bibliothèques s'intègrent harmonieusement dans votre décoration.





| BIBLIOTHÈQUES AVEC PILASTRES |         |          |          |                          |
|------------------------------|---------|----------|----------|--------------------------|
|                              | 1 Niche | 2 Niches | 3 Niches | 1 Niche supplémentaire** |
| Dimensions du socle en cm    | 88 x 33 | 148 x 33 | 208 x 33 | 60 x 33                  |
| Hauteur meuble complet       | 260*    | 260*     | 260*     | 260*                     |
| Référence                    | 30061   | 30062    | 30063    | 30069                    |

\* Possibilité d'adapter la bibliothèque à différentes hauteurs (fabrication spéciale sur devis).

\*\* Possibilité d'augmenter le nombre de niches de la bibliothèque (niche standard).

Les étagères en verre, les spots ainsi que la corniche sont proposés en option.

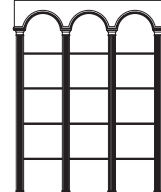

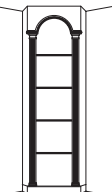
| BIBLIOTHÈQUES AVEC COLONNES |   |   |   |   |   |
|-----------------------------|---|---|---|---|---|
|                             |  |  |  |  |  |
|                             | 1 Niche   | 2 Niches  | 3 Niches  | 1 Niche supplémentaire**  | 1 Niche d'angle***  |
| Dimensions du socle en cm   | 70 x 32   | 130 x 32  | 190 x 32  | 60 x 32   | 80,5 x 80,5   |
| Hauteur meuble complet      | 260*  | 260*  | 260*  | 260*  | 260*  |
| Référence                   | 30051   | 30052   | 30053   | 30059   | 30054   |

\* Possibilité d'adapter la bibliothèque à différentes hauteurs (fabrication spéciale sur devis).

\*\* Possibilité d'augmenter le nombre de niches de la bibliothèque (niche standard).

\*\*\* Possibilité d'accoler des niches standards de chaque côté de la niche d'angle.

Les étagères en verre, les spots ainsi que la corniche sont proposés en option.

## LES MEUBLES BIBLIOTHÈQUES

Comme les bibliothèques, le mobilier présenté ci-après, est constitué d'un ou plusieurs modules standard, livrés en kit, prêts à coller et à peindre.



Les éléments bas du mobilier STAFF DECOR, y compris les portes, sont fabriqués dans un matériau très résistant, constitué d'un mélange de plâtre, de fibre de verre et de résine, que nous avons appelé Résistaff (PMGRG - Norme EN.VF13815).

Les tableaux ci-après, présentent les références des éléments standards selon les options suivantes :

- colonnes lisses ou cannelées.

- meuble accolé à un mur sur son côté gauche ou droit, le côté droit ou gauche étant défini en regardant le meuble de face.

Ce système permet également la réalisation d'un meuble bibliothèque combinant des niches simples et d'angle (nous consulter pour la référence).

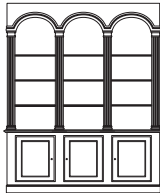
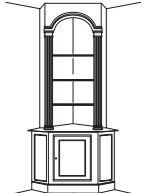
| MEUBLES BIBLIOTHÈQUES        |   |        |   |        |  |        |   |       |  |
|------------------------------|---|--------|---|--------|--|--------|---|-------|--|
|                              |  |        |  |        |  |        |  |       |  |
|                              | 1 Niche   |        | 2 Niches  |        | 3 Niches   |        | 1 Niche d'angle   |       |  |
| Dimensions plateau en cm     | 79 x 44   |        | 136 x 44  |        | 193 x 44   |        | 90 x 90   |       |  |
| Hauteur meuble complet       | 248*  |        | 248*  |        | 248*   |        | 248*  |       |  |
| Référence colonnes cannelées | 5041  |        | 5042  |        | 5043   |        | 5044  |       |  |
| Référence colonnes lisses    | 5051  |        | 5052  |        | 5053   |        | 5054  |       |  |
| Option accolée à un mur      | Gauche  | Droit  | Gauche  | Droit  | Gauche   | Droit  | Gauche  | Droit |  |
| Référence colonnes cannelées | 5061 G  | 5061 D | 5062 G  | 5062 D | 5063 G   | 5063 D | -   | -     |  |
| Référence colonnes lisses    | 5071 G  | 5071 D | 5072 G  | 5072 D | 5073 G   | 5073 D | -   | -     |  |

\* Sur devis possibilité d'adapter le meuble pour des hauteurs jusqu'à 300 cm (fabrication spéciale sur devis).

Possibilité d'augmenter le nombre de niches du meuble (niche standard 57 x 44 cm). Les étagères en verre et les spots sont fournis avec les meubles, (sauf pour les niches d'angle). Étagères en verre : une par niche partie basse, trois par niche partie haute. Spots : un par niche.



## LES MEUBLES DE SALLE DE BAIN

STAFF DÉCOR propose un concept de décor de salle de bain composé d'arcades et de meuble en résistaff réalisés sur mesure. Devis et réalisation sur plan.

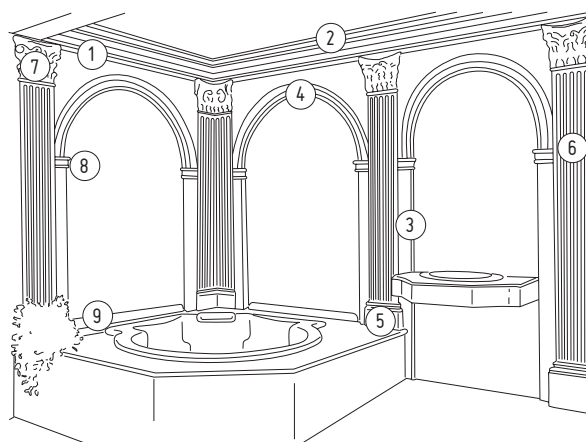

- |                       |                                 |
|-----------------------|---------------------------------|
| 1 - Cornière 17 x 5   | 6 - Pilastre 23 cm, réf. 1050   |
| 2 - Corniche          | 7 - Tête de pilastre, réf. 1055 |
| 3 - U largeur 45 cm   | 8 - Moulure, réf. 1343          |
| 4 - Arcade sur-mesure | 9 - Moulure, réf. 1366          |
| 5 - Socle réf. 1005   |                                 |



Dimensions :  
longueur 210 cm,  
profondeur : 65 cm.

Meuble de salle de bain. Différentes autres configurations sont possibles :

- Meuble avec 2 portes
- Meuble avec 2 portes et tiroirs ...

Le plateau peut être réalisé en Résistaff, marbre, verre, Corian (sur devis)



*Composez-vous même l'ambiance de votre salle de bain  
à l'aide de nos produits !*



PILASTRE 1025  
PAGE 114

CORNICHE D530  
PAGE 36



---

PASSAGE ÉCLAIRANT  
Motif CL10  
PAGE 142

# LES PASSAGES & MEUBLES DE PASSAGE

VOÛTE  
PAGE 141





# LES PASSAGES CLASSIQUES

Droit (1), en arc de cercle (2) ou en anse de panier (3), les habillages de passage, traits d'union de votre décoration, redessinent l'espace et s'intègrent harmonieusement dans tous les styles.

Le staff offre en plus, une grande variété de finitions.



Type 1



Type 2 (ADC)



Type 3 (ADP)

| Largeur cm | DESSOUS DE POUTRE (passage type 1)   |                 |                        |                 | CÔTÉ DE PASSAGE(*)   |                 |
|------------|--------------------------------------|-----------------|------------------------|-----------------|--|-----------------|
|            | Avec rond central                    |                 | Avec rectangle central |                 | Longueur 2.60 ml   | Épaisseur 25 mm |
|            |                                      |                 |                        |                 |  |                 |
|            | Longueur 2.50 ml                     | Épaisseur 25 mm | Longueur 2.50 ml       | Épaisseur 25 mm |  |                 |
| 19         | 22104                                |                 | 22116                  |                 | 2019   |                 |
| 24         | 22105                                |                 | 22117                  |                 | 2024   |                 |
| 32         | 22106                                |                 | 22118                  |                 | 2032   |                 |
| 39         | 22107                                |                 | 22119                  |                 | 2039   |                 |
| 44         | 22108                                |                 | 22120                  |                 | 2044   |                 |
| 50         | 22109                                |                 | 22121                  |                 | 2050   |                 |
| 60         | 22110                                |                 | 22122                  |                 | 2060   |                 |
| Sur mesure | Fabrication sur devis nous consulter |                 |                        |                 | (*) Les côtés de passages peuvent également dans certains cas, être remplacés par des pilastres cannelés |                 |

La longueur du dessous de poutre et des côtés de passage est ajustée en fonction des dimensions du passage existant, lors de la pose de ces éléments.



*Avec rond ou rectangle central.*

Habillage de passage type 1

- dessous de poutre réf. 22107
- côtés réf. 2039
- moulure réf. 1345

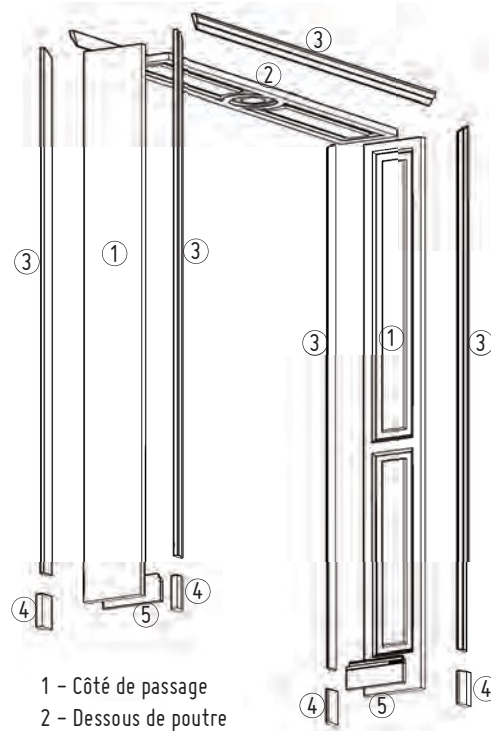

- 1 - Côté de passage
- 2 - Dessous de poutre
- 3 - Moulure
- 4 - Talon
- 5 - Plinthe



VOÛTE AVEC ROND CENTRAL

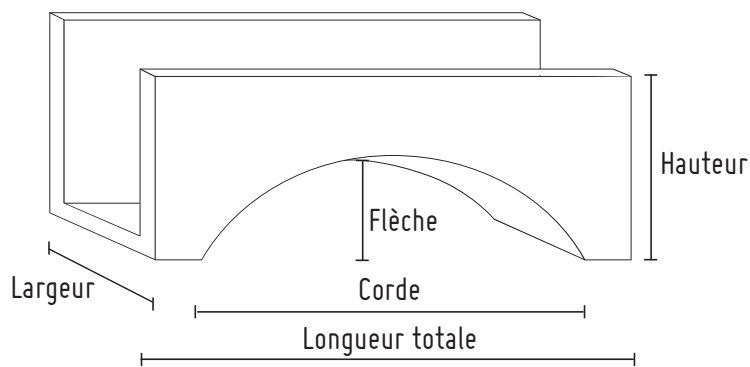

Fabrication en anse de panier ou en arc de cercle sur devis en fonction des dimensions de la voûte souhaitée : largeur, longueur, corde, flèche et hauteur.

- 1 - Côté de passage
- 2 - Voûte
- 3 - Moulure cintrée
- 4 - Moulure
- 5 - Talon
- 6 - Plinthe

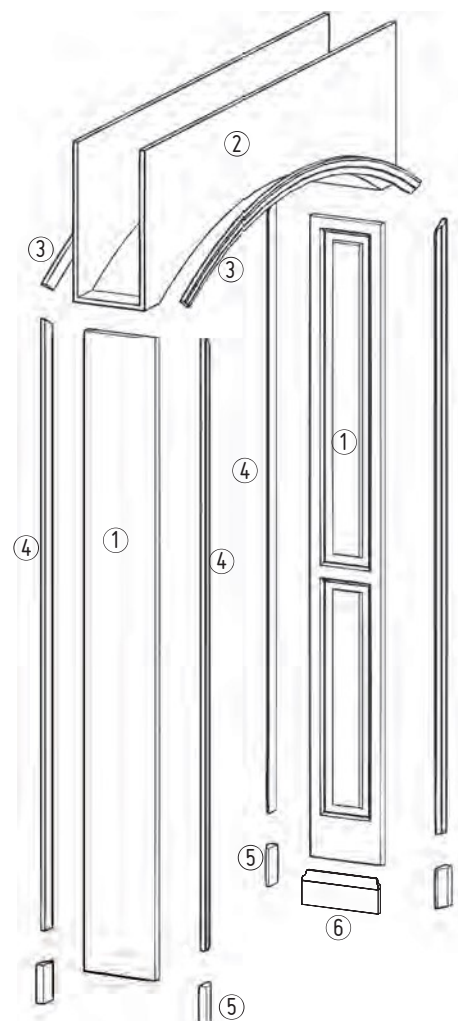

# LES PASSAGES CONTEMPORAINS

Des habillages de passage qui apporteront une touche contemporaine à votre décor.

Différents modèles peuvent être utilisés pour le même passage. Par exemple, deux éléments avec le motif «Anneaux» (Réf.2618) pour les côtés du passage et un élément lisse (Réf. 2718) pour le dessous de poutre.

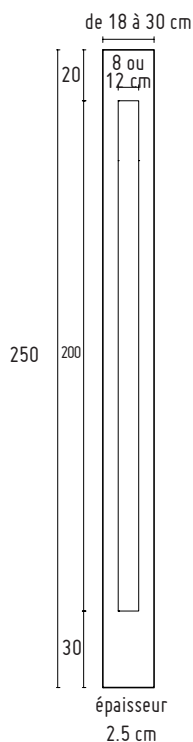

Sur mesure possible.

## Décaissé lisse



2718  
Largeur 18 cm  
(décaissé central 8 cm)

2724  
Largeur 24 cm  
(décaissé central 12 cm)

2730  
Largeur 30 cm  
(décaissé central 12 cm)

## Décaissé motif anneaux



2618  
Largeur 18 cm  
(décaissé central 8 cm)

2624  
Largeur 24 cm  
(décaissé central 12 cm)

2630  
Largeur 30 cm  
(décaissé central 12 cm)

## Décaissé motif CL10



2518  
Largeur 18 cm  
(décaissé central 8 cm)

2524  
Largeur 24 cm  
(décaissé central 12 cm)

2530  
Largeur 30 cm  
(décaissé central 12 cm)

# LES PASSAGES ÉCLAIRANTS

Habillage de passage conçu pour recevoir un ruban LED. L'éclairage met en valeur le motif (CL10, page 92) en soulignant son relief. Ce profil lumineux peut aussi être encastré dans votre mur ou plafond (Réf. 2800L).

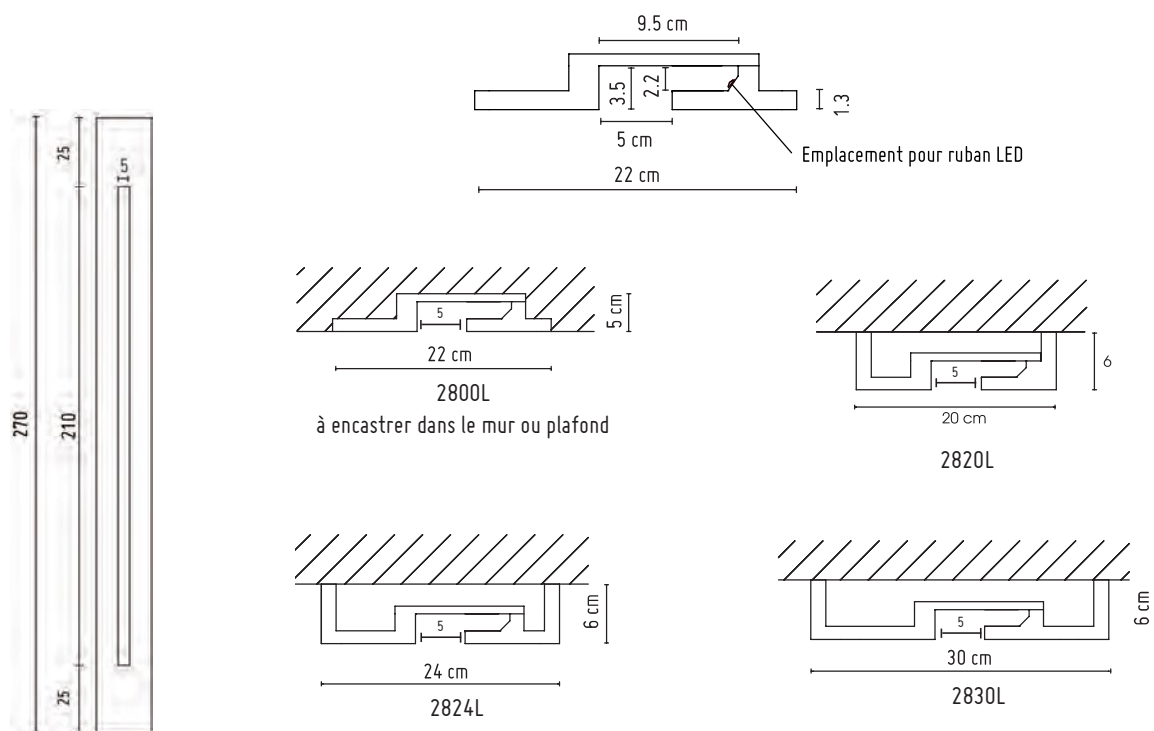

Autres dimensions possibles, nous consulter pour plus d'informations.

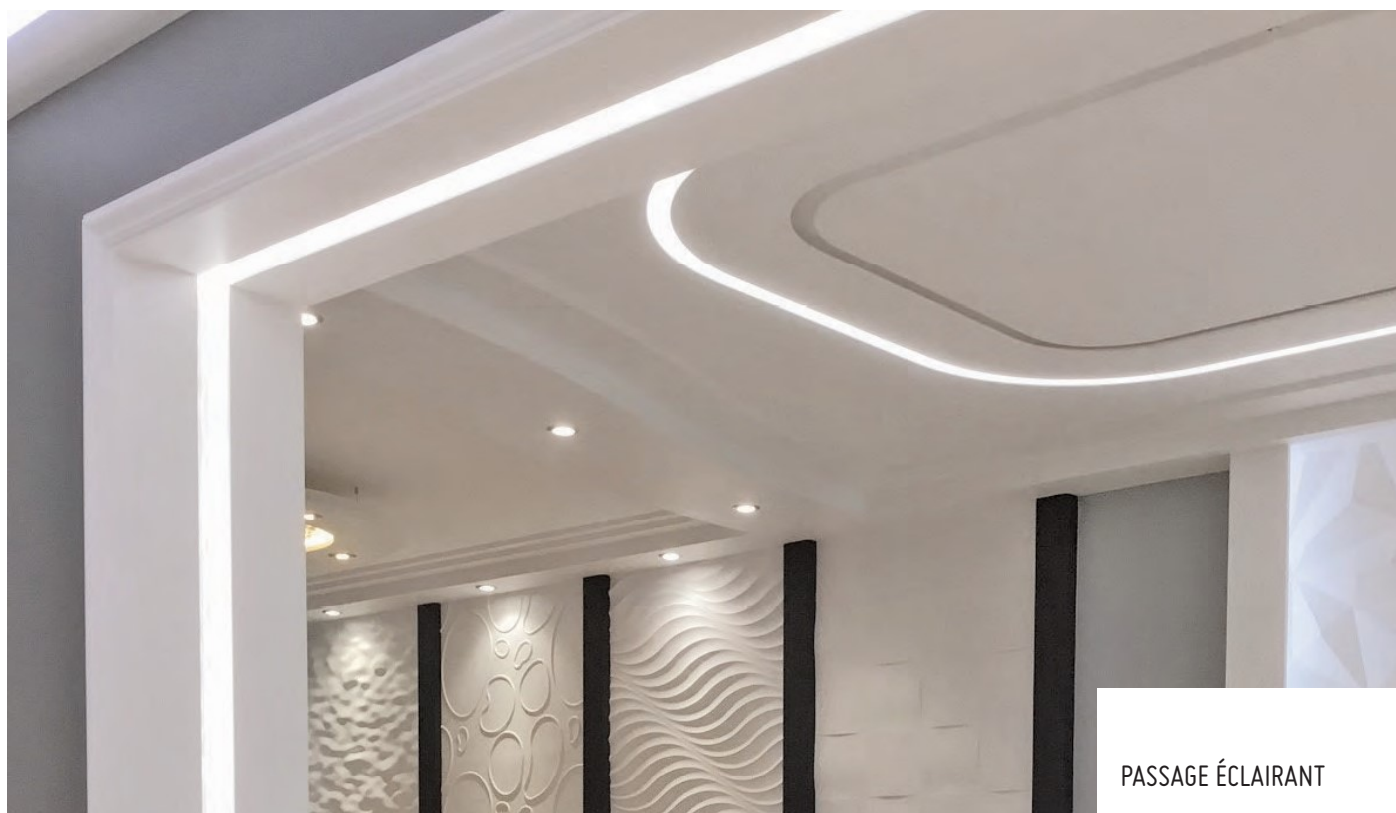

PASSAGE ÉCLAIRANT

# LES MEUBLES DE PASSAGE

*Envie de démarquer vos espaces de façon originale ?*

Meuble passage de style contemporain, prêt à poser, livré en deux éléments :

- une partie basse pré-assemblée
- une colonne lisse, diamètre 20 cm



Laissez-vous guider & inspirez vous de nos compositions !

Élément complet avec étagères en verre et passage

OU

Élément de base avec sa colonne

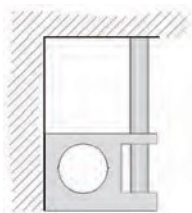
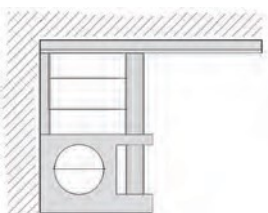

Visuel non contractuel.

|        |  |  |
|--------|--|--|
| 22140  | Ensemble meuble + colonne<br>- Meuble assemblé avec colonne partie basse<br>- Colonne partie haute : diamètre 20 cm - hauteur 200 cm (135 cm avec étagères + poutre) |  |
| VER56  | Etagère verre basse : 56 cm x 35 cm - ép. 8 mm   |  |
| U3225  | Poutre 25 cm + 32 cm + 25 cm - en 200 cm   |  |
| OPT140 | Dessous de poutre avec demi rond : diamètre 4cm - long 200 cm  |  |
| OPT141 | Pilastre galbé avec réservation étagère 32 x 135 cm  |  |
| VER90  | Etagère supérieure : 94 cm x 32 cm - ép. 8 mm  |  |
| SPOT   | Spot GU 10 blanc 230 V avec ampoule GU10 Fluocompacte  |  |

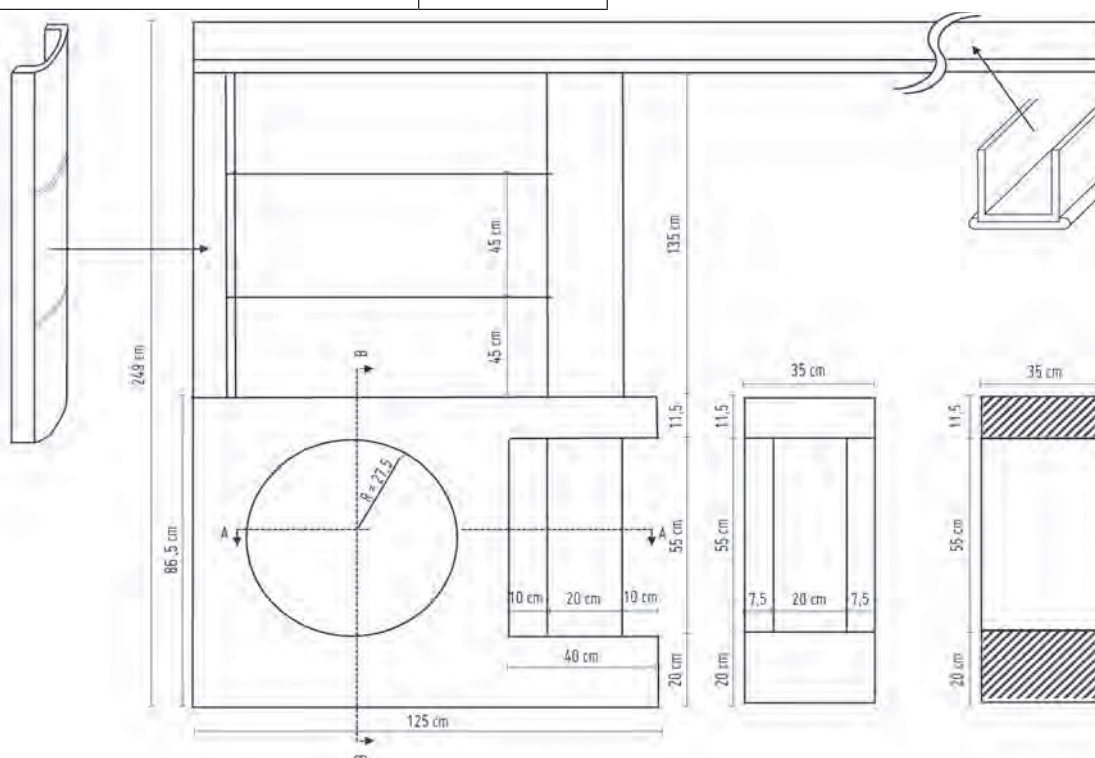

# MEUBLES DE PASSAGE À ESPRIT ⊕ CLASSIQUE

| PASSAGE AVEC MEUBLE DE SÉPARATION                              |                               |   |                         |
|--|-------------------------------|---|-------------------------|
| Cet ensemble référencé 22130M comprend les éléments suivants : |                               |   |                         |
| N°   | Désignation                   | Dimensions  | Options                 |
| 1  | Voûte                         | Corde : 102 cm                                    | - Sous face lisse       |
|  |                               | Flèche : 30 cm                                    | - Sous face décaissée   |
|  |                               | Hauteur 50 cm                                     | Moulure en forme (1125) |
|  |                               |   | Moulure en forme (1101) |
| 2  | Colonne conique avec encoches | Hauteur : 110 cm                                  | - Lisse                 |
|  |                               |   | - Cannelée              |
| 3  | Meuble bas 2 portes           | Hauteur : 84 cm                                   | Recto verso             |
|  |                               | Largeur : 48 cm                                   | Dos décaissé            |
|  |                               | Longueur : 136 cm                                 | /                       |
| 4  | ▭ dessous lisse               | 50 x 32 x 50 cm                                   | /                       |
| 5  | Pilastre lisse avec encoches  | Hauteur : 110 cm                                  | /                       |
|  |                               | Largeur : 32 cm                                   |                         |
| 6  | ▭ côté de passage             | (L) longueur ajustable sur demande jusqu'à 250 cm | /                       |
| 7  | Côté de passage en décaissé   | Hauteur : 194 cm                                  | /                       |
|  |                               | Largeur : 32 cm                                   |                         |

Pour toutes commandes, précisez les options choisies et la dimension de (L).

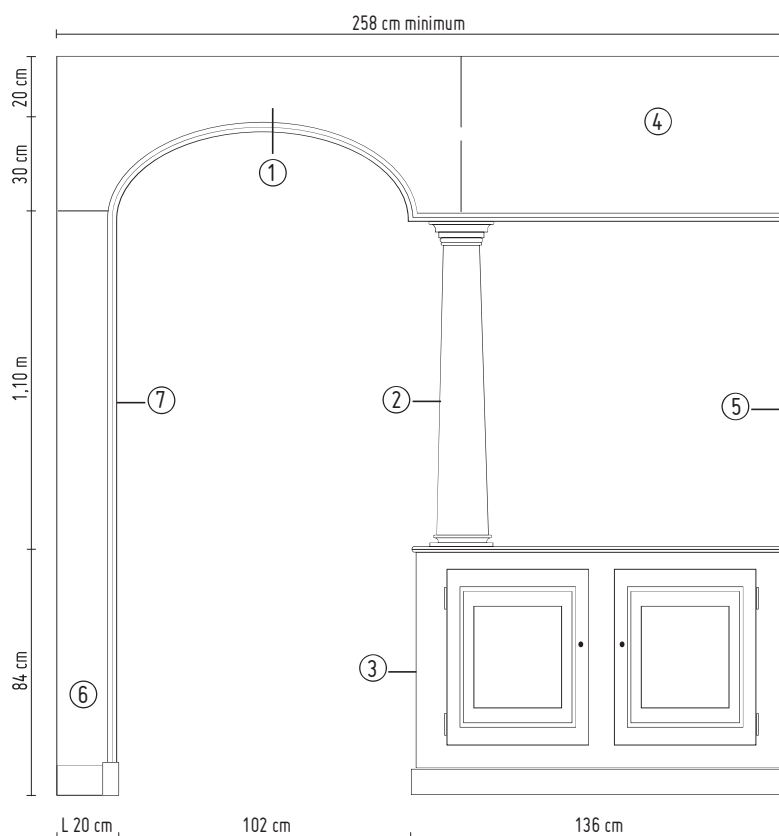



CACHE-RADIATEURS «RONS ALLÉATOIRES»  
PAGE 148

# LES CACHE- RADIATEURS

CACHE-RADIATEUR SUR-MESURE  
DÉCOR CLASSIQUE  
PAGE 149

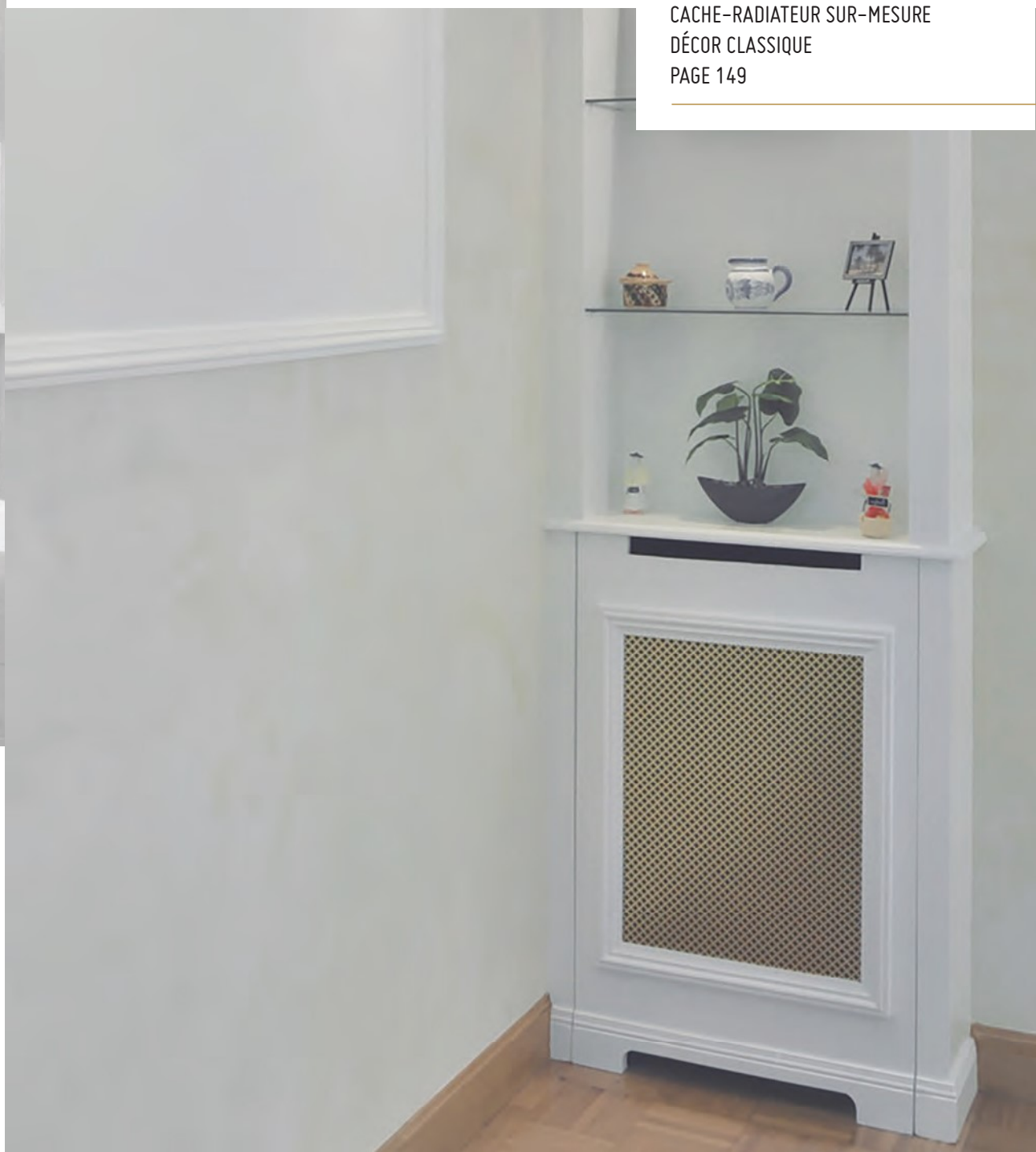



## LES CONTEMPORAINS

Modèle « Constellation»  
Design du motif par Sophie Briand

Avec sa forme épurée et ses motifs légers, le cache-radiateur «Constellation» s'intégrera avec discrétion et élégance dans votre intérieur. Dimensions sur mesure suivant le schéma ci-contre, motif toujours centré de mêmes dimensions. Possibilité d'installer un éclairage (ruban LED) derrière la façade.

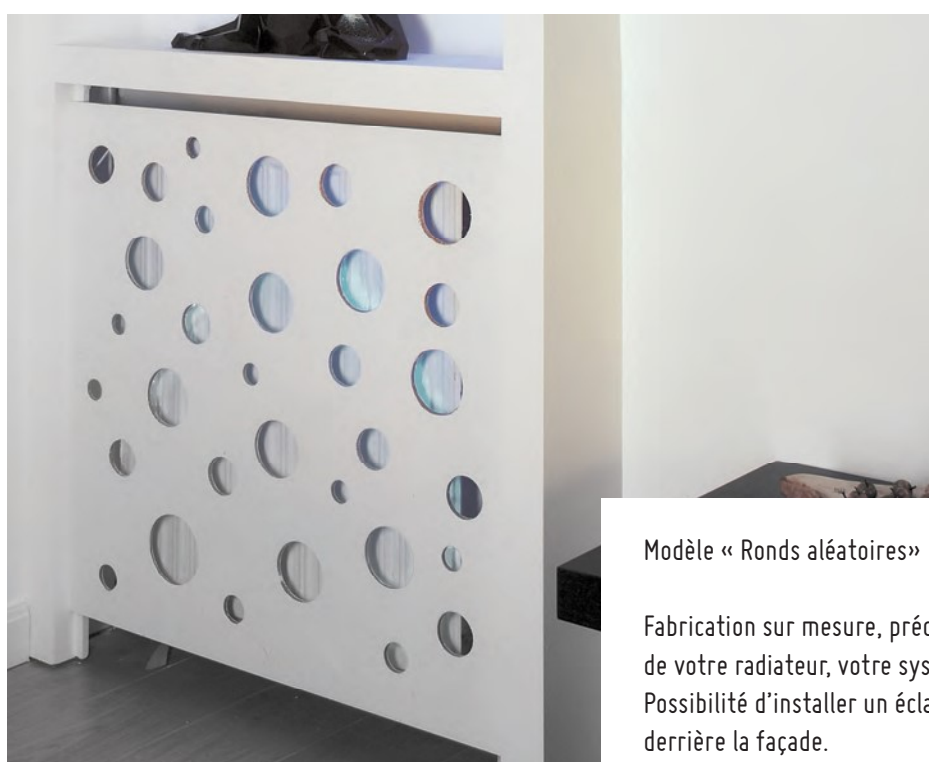
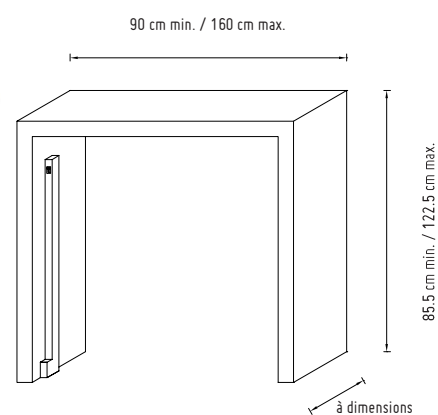
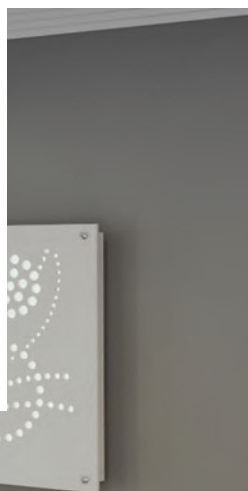

Modèle « Ronds aléatoires»

Fabrication sur mesure, préciser l'encombrement complet de votre radiateur, votre système de réglage compris. Possibilité d'installer un éclairage indirect (ruban LED) derrière la façade.

## LES CLASSIQUES

Pour donner une touche déco à vos radiateurs, sans remettre en cause leur utilité, grâce à des ouvertures prévues pour la circulation de l'air chaud.

La façade amovible permet en outre l'accès au système de réglage du radiateur.

Fabrication sur mesure, préciser l'encombrement complet de votre radiateur, votre système de réglage compris, ainsi que les références de la moulure et la plinthe souhaitées (pour les cache-radiateurs classiques).

CACHE-RADIATEUR CLASSIQUE







← PARURE DE CHEMINÉE  
98506  
PAGE 152

# LES CHEMINÉES

## LES CLASSIQUES



### *Le saviez-vous?*

Le staff est incombustible.

Quoi de plus naturel que de l'utiliser pour habiller vos foyers et hottes de cheminées ?

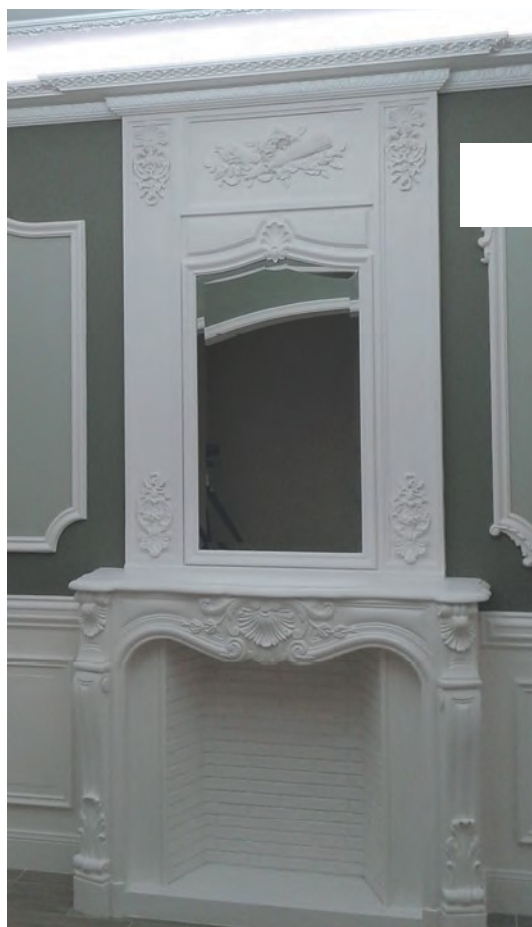

### STYLE LOUIS XV

Réf. 98006

Trumeau (Hauteur sur mesure -max. 1,80m-, L 105 cm)

Réf. 98506

Parure de cheminée

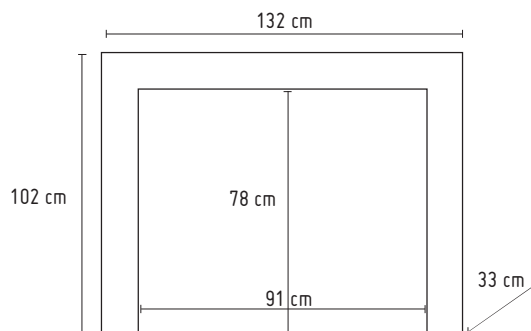

Réf. 98510, parure de cheminée Louis XV, grand modèle

Dimensions : hauteur : 118 cm, longueur : 155 cm, profondeur : 40 cm

Dimensions du trou à feu : longueur : 108 cm, hauteur : 96 cm



### STYLE LOUIS XVI

Réf. 98000

Trumeau (Hauteur sur mesure -max. 1,80m-, L 103 cm)

Réf. 98500

Parure de cheminée

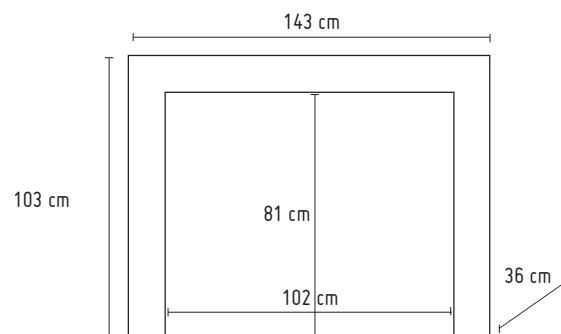

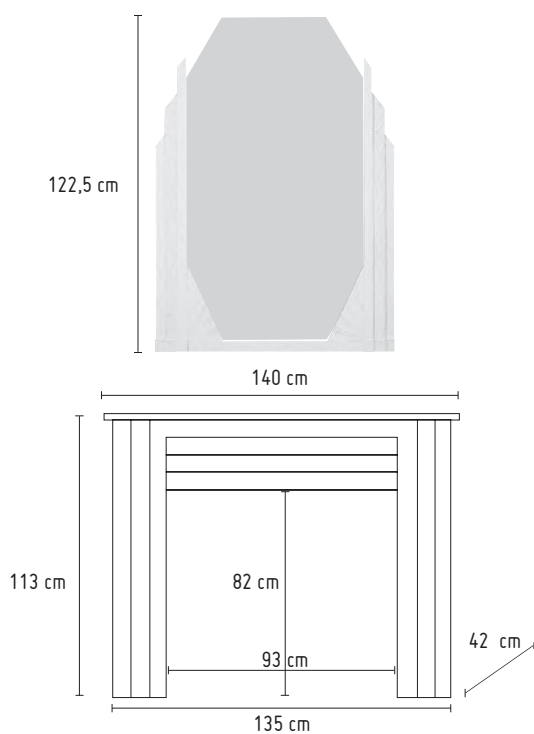

## STYLE ART DÉCO

Réf. 97300  
Miroir Art Déco,  
(H. 122,5 cm, L 84,5 cm)

Réf. 98520  
Parure de cheminée

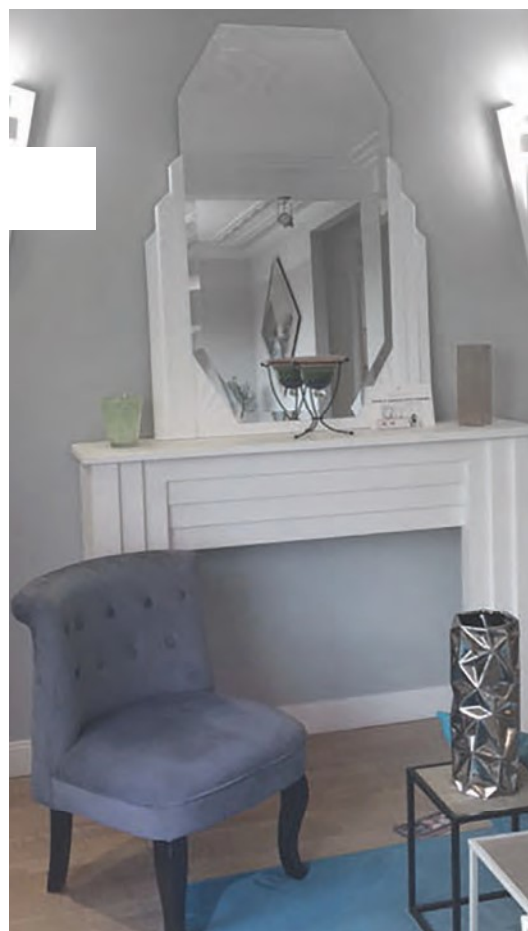

## LES CONTEMPORAINES

Réf. 98530  
Parure de cheminée

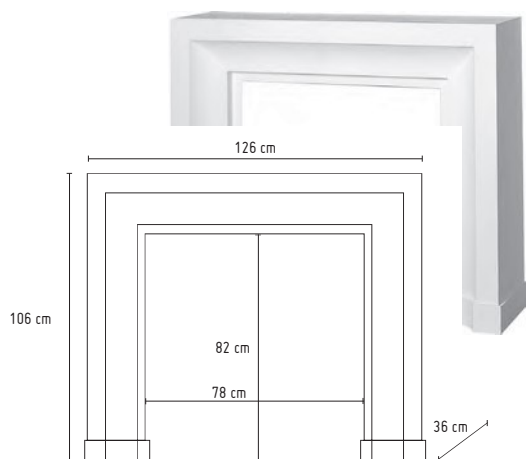

Réf. 98540  
Parure de cheminée

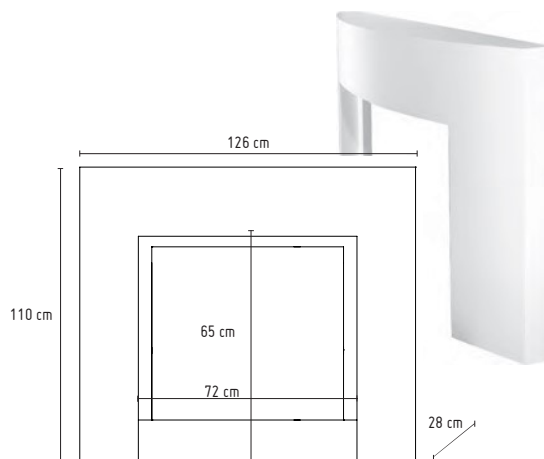





PLAFONNIER PL324F.BF  
PAGE 156

# LES LUMINAIRES



# LES PLAFONNIERS

PL304 - 314 - 324

Plafonniers rectangulaires

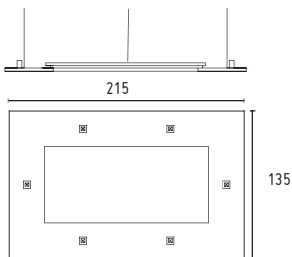

PL304

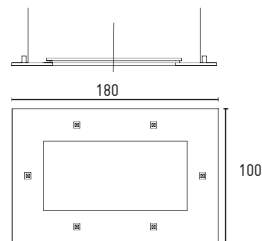

PL314

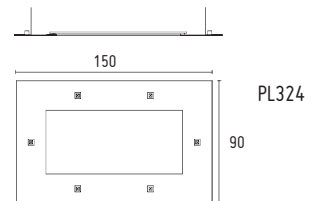

PL324



*Déterminez votre format  
puis choisissez votre modèle  
de plafonnier !*

Rond, carré, rectangulaire...  
Choisissez votre forme,  
piochez un décor.  
Plus d'une centaine  
de combinaisons s'offre à vous !



PLAFONNIER  
PL324F.BF

Équipé de 6 spots carrés LED,  
BC : 6 spots LED 3000 °K • 6 x 600 Lm • IRC 92  
BF : 6 spots LED 4000 °K • 6 x 630 Lm • IRC 92

Partie centrale rétroéclairée par LED

B : LED bleu, C : LED blanc chaud 3000 °K,

F : LED blanc froid 6500 °K.

Rail Alu et ruban LED extérieur.

Suspendu par 4 fils métalliques.

Finition : impression blanche.

En option : Eclairage dimmable par radio.

BC : Blanc Chaud  
BF : Blanc froid

## PL222 & 223 Plafonniers circulaires

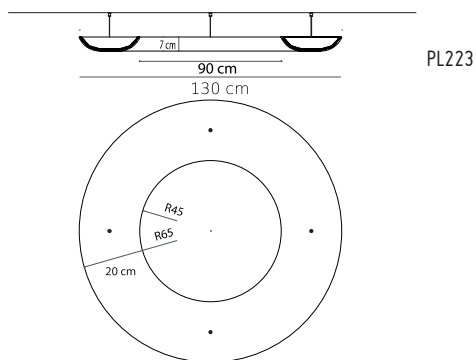
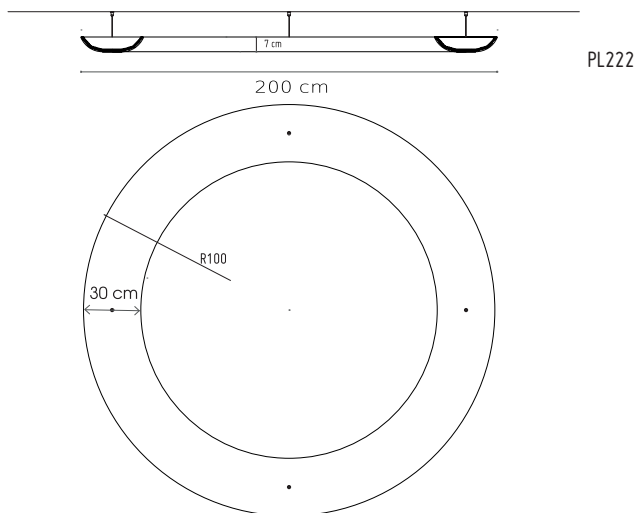

Partie centrale rétroéclairée par LED

BC : LED blanc chaud 3000 °K,

BF : LED blanc froid 6500 °K.

Suspendu par 4 filins métalliques.

Finition : impression blanche.



Retrouvez tous nos plafonniers  
en flashant notre QR CODE !



PL621

Plafonniers suréquipés

80 x 60 x 5,4 cm

Poids : 8,5 kg

Entraxe de perçage :

40 x 30 cm

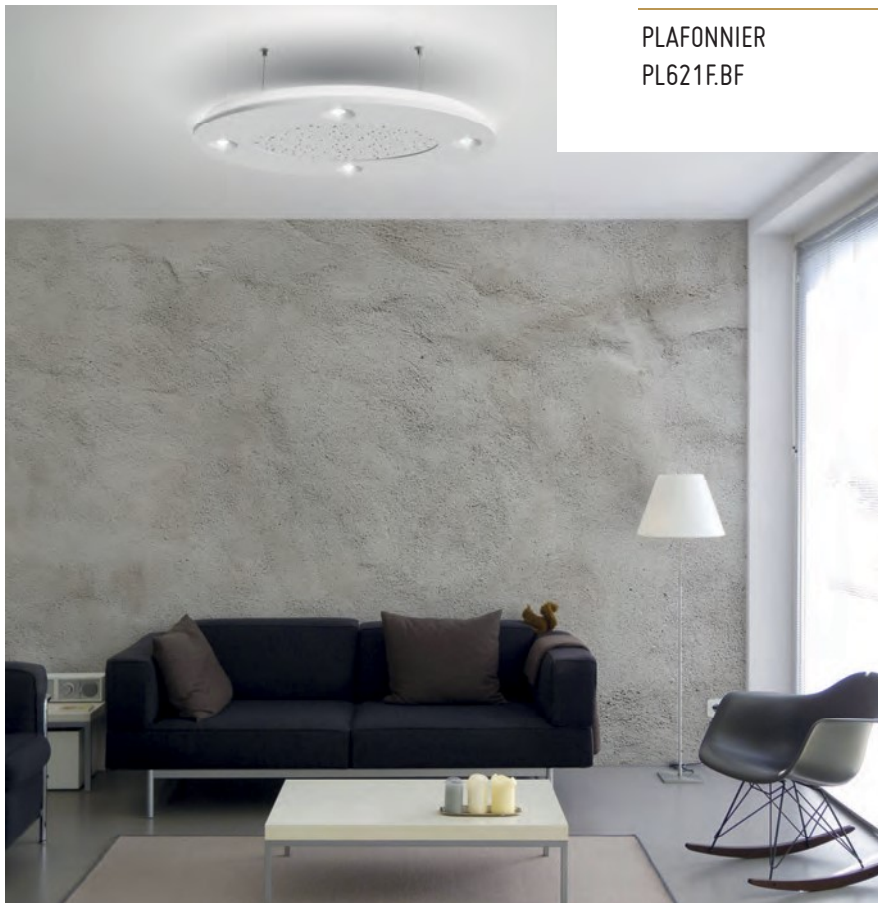

PLAFONNIER  
PL621F.BF

Téléchargez notre catalogue luminaires sur  
[www.staffdecor.fr](http://www.staffdecor.fr) rubrique «Téléchargements»  
en bas de notre site ou demandez le  
auprès de votre conseiller Staff Décor !



*+ de 500 références  
disponibles !*



# LES APPLIQUES

## APPLIQUES



### APPLIQUES

64

L. 26,5 cm x P. 11 cm x H. 55 cm.

Équipement compatible : 57



02

L37,5 cm x P19,5 cm x H20,5 cm

Équipement compatible : 50BC, 50BF, 52, 56

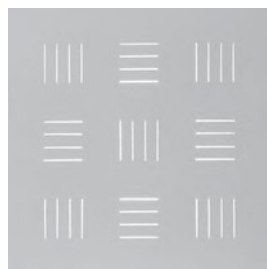

80

L36 cm x P8 cm x H36 cm

Équipement compatible : LED



100

L40 cm x P8 cm x H12 cm

Équipement compatible : 50BC, 50BF

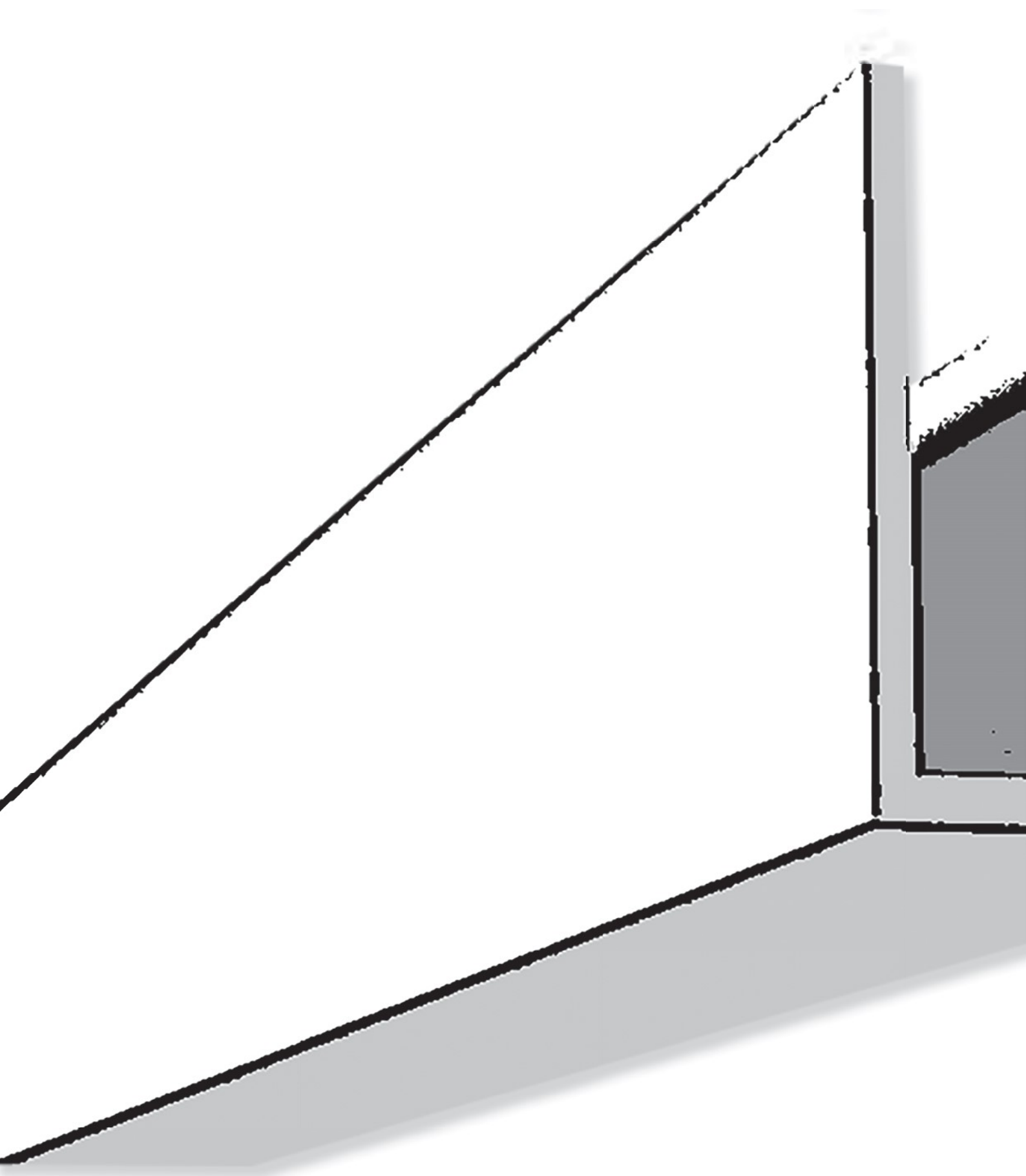

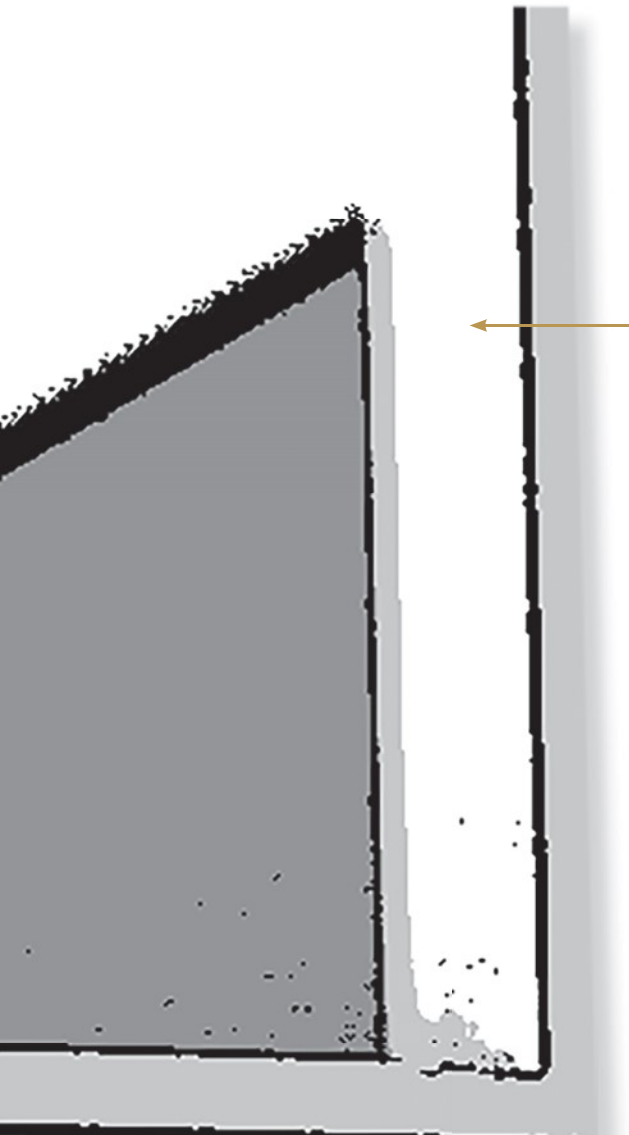

PROFIL U1925  
PAGE 162

# LES PRODUITS TECHNIQUES

## PROFILS EN U



Nos profils en "U" sont livrés en longueur de 2 ml.

Possibilités de fabrications sur-mesure dans d'autres dimensions : délais de fabrication, nous consulter

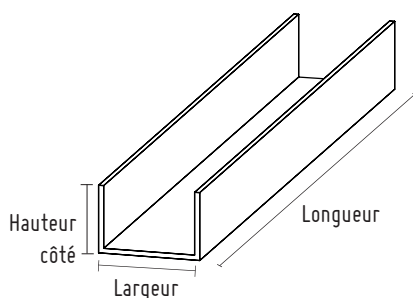

| FINITION «PRÊT À PEINDRE» LISSE EXTÉRIEURE en 2 ml |         |         |
|--|---------|---------|
| Réf.   | Largeur | Hauteur |
| U1910  | 19 cm   | 10 cm   |
| U1925  | 19 cm   | 25 cm   |
| U2410  | 24 cm   | 10 cm   |
| U2425  | 24 cm   | 25 cm   |
| U3210  | 32 cm   | 10 cm   |
| U3225  | 32 cm   | 25 cm   |

## ÉQUERRES



Toutes nos équerres standardisées sont livrées en longueur de 2 ml.

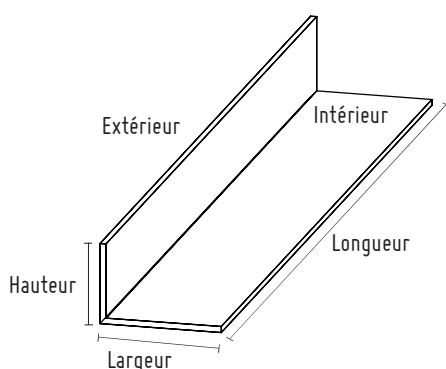

| FINITION «PRÊT À PEINDRE» LISSE EXTÉRIEURE en 2 ml |         |         |
|--|---------|---------|
| Réf.   | Largeur | Hauteur |
| E0510E   | 5 cm    | 10 cm   |
| E0520E   | 5 cm    | 20 cm   |
| E0530E   | 5 cm    | 30 cm   |
| E0535E   | 5 cm    | 35 cm   |
| E1010E   | 10 cm   | 10 cm   |
| E1020E   | 10 cm   | 20 cm   |
| E1030E   | 10 cm   | 30 cm   |
| E1040E   | 10 cm   | 40 cm   |
| E1515E   | 15 cm   | 15 cm   |
| E1520E   | 15 cm   | 20 cm   |
| E2020E   | 20 cm   | 20 cm   |
| E2030E   | 20 cm   | 30 cm   |

| FINITION «PRÊT À PEINDRE» LISSE INTÉRIEURE en 2 ml |         |         |
|--|---------|---------|
| Réf.   | Largeur | Hauteur |
| E1020I   | 10 cm   | 20 cm   |
| E1520I   | 15 cm   | 20 cm   |
| E2020I   | 20 cm   | 20 cm   |
| E2030I   | 20 cm   | 30 cm   |

| FINITION «PRÊT À PEINDRE» ÉQUERRES BORD PROPRE en 2 ml |         |         |
|--|---------|---------|
| Réf.   | Largeur | Hauteur |
| EBP0530  | 30 cm   | 5 cm    |
| EBP0830  | 30 cm   | 8 cm    |
| EBP1030  | 30 cm   | 10 cm   |
| EBP0525P   | 25 cm   | 5 cm    |

## BANDEAUX BORDS PROPRES

| BANDEAUX BORDS PROPRES DE 2ML |         |           |
|-------------------------------|---------|-----------|
| Réf.                          | Largeur | Épaisseur |
| BP20                          | 20 cm   | 1,8 cm    |
| BP30                          | 30 cm   | 1,8 cm    |

## PLAQUES EN STAFF TRADITIONNELLES



Nous vous proposons la plaque de staff à l'unité ou sur palette de 30, 36 ou 50 unités, dans les dimensions et épaisseurs suivantes :



- PLAQ : 151 x 66 cm en épaisseur de 1,5 cm
- PLAQ2 : 120 x 80 cm en épaisseur de 1,5 cm
- PLAQ3 : 120 x 80 cm en épaisseur de 2 cm
- PLAQ5 ; 151 x 66 cm en épaisseur de 8 mm
- PLAQ6 : 120 x 80 cm en épaisseur de 8 mm

## HABILLAGE DES NEZ DE CLOISONS

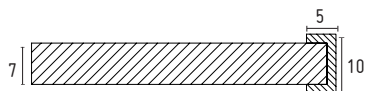

| FINITION LISSE EXTÉRIÈRE POUR NEZ DE CLOISON EN 2,50 ML |         |         |
|---|---------|---------|
| Réf.  | Largeur | Hauteur |
| UF1005  | 10 cm   | 5 cm    |

## LE SYSTÈME DE CLOISONS & DE PLAFONDS



Accrochage mécanique sur ossature métallique. Finition des joints au plâtre pour le scellement.  
Demandez à votre conseiller Staff Décor nos fiches techniques et conseils de pose !



Plaque de cloison



Plaque de plafond

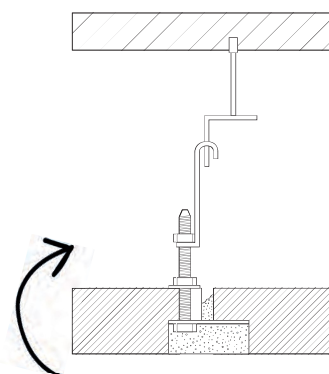

Vue en coupe du système de plafond (système breveté).

## LES ENDUITS & MATÉRIEL DE POSE



La colle-enduit STAFF DÉCOR : Facile à travailler, elle reste blanche après séchage et peut être utilisée pour le collage, le rebouchage et la finition. Son utilisation est conseillée pour l'ensemble des produits de notre gamme.

- 0029 en sac de 5 Kg.
- 0010 en seau de 10 kg.
- 0028 en sac de 25 Kg.



Boîte à coupe adaptée à la dimension des corniches, que vous aurez réglée en fonction de leur encombrement sur le mur et le plafond (côtes de pose conseillées indiquées en face de chaque référence) :

- Boîte à coupe en 1 ml : 0005.
- Boîte à coupe en 2 ml : 0006.
- Boîte à coupe grand modèle en 2 ml : 0007.



Etais de pose télescopiques : 0018

Ces étais servent à soutenir l'élément collé pendant le temps de prise de l'enduit.



# INDEX

| Référence produit | Page     | Référence produit | Page           | Référence produit | Page         |
|-------------------|----------|-------------------|----------------|-------------------|--------------|
| 0005              | 163      | 1000              | 100-114        | 1130              | 40 - 106     |
| 0006              | 163      | 1001              | 114            | 1140C             | 102          |
| 0007              | 163      | 1002              | 114            | 1141C             | 103          |
| 0010              | 92 - 163 | 1003              | 100-114        | 1145C             | 103          |
| 0018              | 163      | 1004              | 114            | 1150              | 42 - 46      |
| 0028              | 163      | 1005              | 114 - 136      | 1150BH            | 46           |
| 0029              | 163      | 1025              | 114 - 137      | 1151              | 42 - 46      |
| 0034              | 104      | 1050              | 114 - 136      | 1151BH            | 46           |
| 0036              | 104      | 1055              | 114 - 136      | 1153              | 46           |
| 02                | 159      | 1101              | 41-40-47-145   | 1155              | 40           |
| 0710              | 129      | 1101BH            | 47             | 1156              | 40 - 105     |
| 0712              | 129      | 1101C             | 70 - 103       | 1157              | 42           |
| 0714              | 128      | 1101D             | 47             | 1165              | 106          |
| 0724              | 128      | 1101F             | 47             | 1166              | 40           |
| 0726              | 128      | 1101G             | 47             | 1200              | 40 - 46      |
| 0732              | 129      | 1101H             | 47             | 1200BH            | 46           |
| 0734              | 128      | 1101P             | 47             | 1201              | 40           |
| 0742              | 129      | 1102              | 40 - 43 - 47   | 1202              | 40 - 47      |
| 0744              | 128      | 1102BH            | 47             | 1202B             | 47           |
| 0760              | 116      | 1103              | 40 - 46        | 1202BH            | 47           |
| 0761              | 116      | 1103BH            | 46             | 1202H             | 47           |
| 0762              | 116      | 1103C             | 103            | 1203              | 43 - 47      |
| 0765              | 116      | 1103D             | 44 - 46        | 1204              | 12 - 42 - 47 |
| 0780              | 116      | 1103H             | 46             | 1204BH            | 47           |
| 0781              | 116      | 1104              | 42 - 46        | 1204H             | 13 - 45 - 47 |
| 0782              | 116      | 1104B             | 46             | 1205              | 42           |
| 0785              | 116      | 1104H             | 46             | 1206              | 40 - 46      |
| 0800              | 71 - 116 | 1105              | 42 - 46        | 1206R             | 46           |
| 0801              | 116      | 1105B             | 46             | 1206S             | 46           |
| 0802              | 116      | 1105H             | 46             | 1207              | 40 - 47      |
| 0803              | 116      | 1106              | 42             | 1207BH            | 47           |
| 0804              | 116      | 1107              | 40 - 47        | 1208              | 42 - 47      |
| 0805              | 116      | 1107BH            | 47             | 1208D             | 47           |
| 0806              | 116      | 1107P             | 47             | 1209              | 40           |
| 0900              | 117      | 1108              | 40 - 105 - 106 | 1210              | 40 - 46      |
| 0901              | 117      | 1109              | 42             | 1210BH            | 46           |
| 0902              | 117      | 1110              | 42             | 1250D             | 68           |
| 0903              | 117      | 1111              | 42             | 1250G             | 67 - 68      |
| 0904              | 117      | 1112              | 42             | 1251              | 68           |
| 0905              | 117      | 1113              | 42             | 1252              | 68           |
| 0950              | 115      | 1114D             | 42             | 1253              | 68           |
| 0951              | 115      | 1114G             | 42             | 1254              | 68           |
| 0952              | 115      | 1120              | 40 - 106       | 1271              | 68           |
| 0955              | 115      | 1121              | 40 - 106       | 1275              | 68           |
| 0999              | 114      | 1124              | 40 - 106       | 1301              | 38 - 42      |
| 100               | 159      | 1125              | 40 - 106 - 145 | 1302              | 38 - 42      |
|                   |          |                   |                | 1303              | 13- 38 - 42  |
|                   |          |                   |                | 1304              | 38 - 42      |
|                   |          |                   |                | 1305              | 42           |
|                   |          |                   |                | 1306              | 42           |
|                   |          |                   |                | 1310              | 42           |
|                   |          |                   |                | 1320              | 43           |
|                   |          |                   |                | 1321              | 42           |

| Référence produit | Page           | Référence produit | Page      | Référence produit | Page |
|-------------------|----------------|-------------------|-----------|-------------------|------|
| 1322              | 42             | 1420M             | 47        | 2624              | 142  |
| 1323              | 42             | 1420T             | 47        | 2630              | 142  |
| 1324              | 40             | 20.01             | 109       | 2718              | 142  |
| 1325              | 42             | 20.02             | 108 - 111 | 2724              | 142  |
| 1326              | 42             | 20.03             | 109       | 2730              | 142  |
| 1327              | 42             | 20.04             | 108       | 2800L             | 143  |
| 1328              | 42             | 20.05             | 108       | 2820L             | 143  |
| 1329              | 42             | 20.06             | 110 - 112 | 2824L             | 143  |
| 1330              | 42             | 20.06B            | 110 - 112 | 2830L             | 143  |
| 1331              | 42             | 20.06H            | 112       | 22104             | 140  |
| 1332              | 42             | 20.06S            | 110 - 112 | 22105             | 140  |
| 1333              | 42             | 20.08             | 110 - 112 | 22106             | 140  |
| 1334              | 43             | 20.51             | 109       | 22107             | 140  |
| 1335              | 43             | 20.52             | 108       | 22108             | 140  |
| 1340              | 42             | 20.53             | 109       | 22109             | 140  |
| 1341              | 43             | 20.54             | 108       | 22110             | 140  |
| 1342              | 43             | 20.55             | 108       | 22116             | 140  |
| 1343              | 40 - 136       | 20.56             | 110 - 112 | 22117             | 140  |
| 1344              | 40             | 20.56B            | 110 - 112 | 22118             | 140  |
| 1345              | 39-40-41-140   | 20.56H            | 112       | 22119             | 140  |
| 1346              | 43             | 20.56S            | 110 - 112 | 22120             | 140  |
| 1347              | 43             | 20.57             | 112       | 22121             | 140  |
| 1348              | 43             | 20.57BD           | 112       | 22122             | 140  |
| 1349              | 43             | 20.57BG           | 112       | 22130M            | 145  |
| 1364              | 40 - 106       | 20.57HD           | 112       | 22140             | 144  |
| 1365              | 40             | 20.57HG           | 112       | 22150             | 132  |
| 1366              | 40 - 106 - 136 | 20.57SD           | 112       | 22160.445         | 132  |
| 1367              | 40 - 106       | 20.57SG           | 112       | 22160.545         | 132  |
| 1371              | 43             | 20.58             | 110-112   | 22160.605         | 132  |
| 1372              | 43             | 20.59             | 112       | 22160.675         | 132  |
| 1373              | 43             | 201               | 68        | 30.02             | 110  |
| 1374              | 42 - 93        | 2000              | 100-113   | 30.03             | 110  |
| 1380              | 40             | 2001              | 113       | 30.04             | 110  |
| 1400              | 50             | 2004              | 100-113   | 30.05             | 110  |
| 1401              | 50             | 2005              | 113       | 30.06             | 110  |
| 1402              | 50             | 2019              | 140       | 30.07             | 110  |
| 1403              | 50             | 2020              | 113       | 30.08             | 110  |
| 1404              | 50             | 2024              | 70 - 140  | 30.09             | 110  |
| 1405              | 50             | 2030              | 115       | 30.10             | 110  |
| 1406              | 50             | 2030M             | 115       | 30.11             | 110  |
| 1407              | 50             | 2031              | 114 - 115 | 30.12             | 110  |
| 1408              | 50             | 2031C             | 115       | 30.52             | 110  |
| 1409              | 12 - 47        | 2031M             | 115       | 30.53             | 110  |
| 1410              | 47             | 2032              | 140       | 30.54             | 110  |
| 1411D             | 47             | 2039              | 140       | 30.55             | 110  |
| 1411G             | 47             | 2044              | 140       | 30.56             | 110  |
| 1412              | 50             | 2050              | 140       | 30.57             | 110  |
| 1413              | 50             | 2060              | 140       | 30.58             | 110  |
| 1414              | 50             | 2518              | 142       | 30.59             | 110  |
| 1415              | 50             | 2524              | 142       | 30.60             | 110  |
| 1416              | 50             | 2530              | 142       | 30.61             | 110  |
| 1420H             | 47             | 2618              | 142       | 30.62             | 110  |

| Référence produit | Page            | Référence produit | Page         | Référence produit | Page    |
|-------------------|-----------------|-------------------|--------------|-------------------|---------|
| 30.63             | 110             | 41.51             | 110          | 5032G             | 133     |
| 31.01             | 110             | 41.52             | 110          | 5033D             | 133     |
| 31.02             | 110             | 41.53             | 110          | 5033G             | 133     |
| 31.03             | 110             | 41.55             | 110          | 5034D             | 133     |
| 31.04             | 110             | 45.01             | 110          | 5034G             | 133     |
| 31.51             | 110             | 45.02             | 110          | 5041              | 134     |
| 31.52             | 110             | 45.03             | 110          | 5042              | 134     |
| 31.53             | 110             | 45.04             | 110          | 5043              | 134     |
| 31.54             | 110             | 45.05             | 110          | 5044              | 134     |
| 32.51             | 69              | 45.06             | 110          | 5051              | 134     |
| 3000              | 115             | 45.07             | 110          | 5052              | 134     |
| 3800              | 47              | 45.51             | 110          | 5053              | 134     |
| 3900              | 71 - 106        | 45.51C            | 69           | 5054              | 134     |
| 3901              | 107             | 45.52             | 110          | 5061D             | 134     |
| 3902              | 106             | 45.53             | 110          | 5061G             | 134     |
| 3903              | 107             | 45.54             | 110          | 5062D             | 134     |
| 3904              | 107             | 45.55             | 110          | 5062G             | 134     |
| 3905              | 106             | 45.56             | 110          | 5063D             | 134     |
| 3906              | 114             | 45.57             | 110          | 5063G             | 134     |
| 30051             | 134             | 4200              | 47           | 5071D             | 134     |
| 30052             | 134             | 4201              | 47           | 5071G             | 134     |
| 30053             | 134             | 50.050            | 65           | 5072D             | 134     |
| 30054             | 134             | 50.ATLA           | 65           | 5072G             | 134     |
| 30059             | 134             | 50.LET1           | 84           | 5073D             | 134     |
| 30061             | 133             | 50.LET2           | 84           | 5073G             | 134     |
| 30062             | 133             | 50.LET3           | 84           | 64                | 159     |
| 30063             | 133             | 50.NIAG           | 48 - 64 - 65 | 6200              | 129     |
| 30069             | 133             | 50.SIER           | 65           | 7001              | 117     |
| 40.01             | 108 - 109 - 111 | 50BC              | 159          | 7002              | 117     |
| 40.02             | 109             | 50BF              | 159          | 7003              | 117     |
| 40.03             | 108             | 52                | 159          | 7004              | 117     |
| 40.04             | 108 - 110       | 56                | 159          | 7005              | 117     |
| 40.05             | 109 - 110       | 57                | 159          | 7006              | 117     |
| 40.06             | 108 - 110       | 5001              | 133          | 7035              | 88      |
| 40.07             | 108             | 5002              | 133          | 7036              | 89      |
| 40.07A            | 108             | 5003              | 133          | 7036PLIN          | 89      |
| 40.08             | 108             | 5004              | 133          | 7036U             | 89      |
| 40.09             | 108             | 5011              | 133          | 7038              | 76      |
| 40.10             | 108 - 109       | 5012              | 133          | 7039A             | 90      |
| 40.20             | 109             | 5013              | 133          | 7039B             | 90      |
| 40.30             | 108             | 5014              | 133          | 7040              | 76      |
| 40.40             | 108 - 110       | 5021D             | 133          | 7041              | 76 - 77 |
| 40.50             | 109 - 110       | 5021G             | 133          | 7048              | 77      |
| 40.60             | 108 - 110       | 5022D             | 133          | 7049              | 77      |
| 40.61             | 69              | 5022G             | 133          | 7051              | 77      |
| 40.70             | 108             | 5023D             | 133          | 7053              | 77      |
| 40.70A            | 108             | 5023G             | 133          | 7060              | 76      |
| 40.80             | 108             | 5024D             | 133          | 7061              | 76      |
| 40.90             | 108             | 5024G             | 133          | 7062              | 91      |
| 41.01             | 110             | 5031D             | 133          | 7063              | 75 - 91 |
| 41.02             | 110             | 5031G             | 133          |                   |         |
| 41.03             | 110             | 5032D             | 133          |                   |         |

| Référence produit | Page          | Référence produit | Page     | Référence produit   | Page         |
|-------------------|---------------|-------------------|----------|---------------------|--------------|
| 7063-1            | 91            | 942.73            | 105      | 9411                | 101          |
| 7063-2            | 91            | 942.83            | 105      | 9412                | 101          |
| 7063-3            | 91            | 943.63            | 105      | 9413                | 101          |
| 7063-4            | 91            | 943.73            | 105      | 9450                | 100          |
| 7070              | 82            | 943.83            | 105      | 9451                | 100          |
| 7071              | 82            | 950.63            | 105      | 9460                | 100          |
| 7072              | 82 - 83 - 119 | 950.73            | 105      | 9461                | 100          |
| 7073              | 78 - 82       | 950.83            | 105      | 97300               | 153          |
| 7074              | 82            | 952.63            | 105      | 98000               | 152          |
| 7075              | 82            | 952.73            | 105      | 98006               | 152          |
| 7078              | 84            | 952.83            | 105      | 98500               | 152          |
| 80                | 159           | 960.00            | 104      | 98506               | 151 - 152    |
| 901.63            | 105           | 9001              | 103      | 98510               | 152          |
| 901.73            | 105           | 9002              | 103      | 98520               | 153          |
| 901.83            | 105           | 9003              | 103      | 98530               | 153          |
| 902.63            | 105           | 9011              | 103      | 98540               | 153          |
| 902.73            | 105           | 9012              | 103      | A.OT20/24           | 131          |
| 902.83            | 105           | 9013              | 103      | AA-R1707            | 131          |
| 903.63            | 105           | 9020              | 102      | APPLIQUES série 110 | 6            |
| 903.73            | 105           | 9021              | 102      | B700                | 66 - 69      |
| 903.83            | 105           | 9025              | 102      | B701                | 69           |
| 911.63            | 105           | 9031              | 103      | B702                | 69           |
| 911.73            | 105           | 9032              | 103      | B703                | 69           |
| 911.83            | 105           | 9033              | 103      | BL120               | 26 - 27      |
| 912.63            | 105           | 9201              | 99       | BL130               | 28           |
| 912.73            | 105           | 9202              | 99       | BL131               | 28           |
| 912.83            | 105           | 9203              | 99       | BL132               | 28           |
| 913.63            | 105           | 9204              | 99       | BL140               | 28           |
| 913.73            | 105           | 9205              | 99       | BL160               | 28           |
| 913.83            | 105           | 9206              | 99       | BL170               | 29           |
| 921.63            | 105           | 9211              | 99 - 102 | BL170R25E           | 29           |
| 921.73            | 105           | 9212              | 99       | BL170R25I           | 29           |
| 921.83            | 105           | 9213              | 99       | BL170R50E           | 29           |
| 922.63            | 105           | 9214              | 99       | BL170R50I           | 29           |
| 922.73            | 105           | 9215              | 99       | BL180               | 9            |
| 922.83            | 105           | 9216              | 99       | BP20                | 162          |
| 930.63            | 105           | 9221              | 99       | BP30                | 162          |
| 930.73            | 105           | 9222              | 99       | CHEVET1             | 131          |
| 930.83            | 105           | 9223              | 99       | CHEVET2D            | 131          |
| 9315.23           | 101           | 9224              | 99       | CHEVET2G            | 131          |
| 9315.30           | 101           | 9225              | 99       | CIEL DE LIT         | 7            |
| 9315C             | 98 - 102      | 9226              | 99       | CL10                | 92 - 143     |
| 932.63            | 105           | 9280              | 101      | CL11                | 92           |
| 932.73            | 105           | 9301              | 98       | CL12                | 94 - 95      |
| 932.83            | 105           | 9302              | 98       | CL1374              | 93 - 95      |
| 933.63            | 105           | 9303              | 98       | CL31                | 74           |
| 933.73            | 105           | 9310              | 98       | CL31A               | 86           |
| 933.83            | 105           | 9311              | 98       | CL31B               | 86           |
| 940.63            | 105           | 9312              | 98       | CL32                | 78 - 79 - 87 |
| 940.73            | 105           | 9401              | 101      | CL33                | 87           |
| 940.83            | 105           | 9402              | 101      | CL34                | 88           |
| 942.63            | 105           | 9403              | 101      | CL35                | 88           |

| Réf. produit | Page          | Réf. produit | Page    | Réf. produit | Page    | Réf. produit | Page    |
|--------------|---------------|--------------|---------|--------------|---------|--------------|---------|
| CL36         | 8-88          | D604         | 31      | D801         | 30 - 33 | E2030E       | 162     |
| CL37         | 8             | D605         | 31      | D802         | 30      | E2030I       | 162     |
| C080         | 37            | D606         | 32      | D810         | 34      | EBL0430      | 27      |
| C090         | 37            | D607         | 32      | D812         | 35      | EBP0525P     | 162     |
| C0100        | 37            | D608         | 31      | D813         | 35      | EBP0530      | 162     |
| C0105        | 37            | D609         | 31      | D814         | 34      | EBP0830      | 162     |
| C0110        | 37            | D610         | 31      | D815         | 34      | EBP1030      | 162     |
| C0120        | 37            | D611         | 31      | D818         | 36      | EMB95        | 27      |
| D101         | 25            | D612         | 31      | D820         | 33      | ENC31        | 10      |
| D102         | 25            | D614         | 31      | D830         | 31      | ENC32        | 10      |
| D103         | 25            | D615         | 36      | D835         | 36      | ENC35        | 10      |
| D104         | 25            | D616         | 32      | D840         | 34      | ENC41        | 11      |
| D105A        | 25            | D617         | 34      | D843         | 35      | JC22.10      | 23      |
| D105B        | 25            | D620         | 19      | D844         | 35 - 37 | JC22.20      | 23      |
| D106         | 26            | D621         | 19      | D845         | 35      | JC22.30      | 23      |
| D107         | 26            | D622         | 32      | D846         | 36      | JC22.40      | 23      |
| D108         | 26            | D623         | 32      | D880         | 32      | JC55.10      | 23      |
| D110         | 26            | D624         | 32      | D880A        | 32      | JC55.20      | 23      |
| D118         | 9             | D625         | 31      | D880B        | 6       | M038         | 50      |
| D121         | 9             | D626         | 31      | D884         | 35      | M039         | 59      |
| D505         | 35 - 37       | D627         | 36      | D885         | 35      | M040         | 51      |
| D510         | 35 - 37       | D628         | 34      | D886         | 33      | M041         | 51      |
| D513         | 36            | D629         | 34      | D888         | 33      | M042         | 51      |
| D515         | 34            | D630         | 31      | D889         | 34      | M043         | 51      |
| D520         | 31            | D631         | 19      | D890         | 36      | M044         | 51      |
| D525         | 36            | D650         | 32 - 33 | D890A        | 36      | M045         | 53      |
| D530         | 36 - 137      | D651         | 32      | D891         | 18      | M046         | 53      |
| D531         | 34            | D652         | 32      | D892         | 30      | M047         | 51      |
| D535         | 36            | D653         | 33      | D893         | 35      | M048         | 59      |
| D540         | 36            | D654         | 32      | D894         | 35      | M049         | 50      |
| D545         | 31            | D655         | 36      | D895         | 35      | M050         | 50      |
| D550         | 36            | D656         | 33      | D896         | 33      | M051         | 52      |
| D555         | 19            | D657         | 33      | D897         | 35      | M052         | 55      |
| D560         | 30            | D702         | 32      | D898         | 16 - 34 | M053         | 53      |
| D561         | 19            | D703         | 31      | D899         | 34      | M054         | 62      |
| D562         | 19            | D704         | 31      | D900         | 30      | M055         | 53      |
| D563         | 19            | D705         | 19      | D901         | 19      | M056         | 52      |
| D564         | 18            | D706         | 19      | D902         | 34      | M057         | 52      |
| D565         | 18 - 19       | D707         | 31      | E0510E       | 162     | M058         | 51      |
| D566         | 35            | D708         | 24      | E0520E       | 162     | M059         | 52      |
| D567         | 18            | D709         | 24      | E0530E       | 162     | M060         | 63      |
| D568         | 18            | D710         | 24      | E0535E       | 162     | M061         | 52      |
| D569         | 34            | D711         | 36      | E1010E       | 162     | M066         | 62      |
| D570         | 35            | D712         | 36      | E1020E       | 162     | M067         | 60      |
| D574         | 31            | D713         | 33      | E1020I       | 162     | M068         | 59      |
| D575         | 17 - 19 - 119 | D715         | 34      | E1030E       | 162     | M069         | 59      |
| D576         | 19            | D716         | 36      | E1040E       | 162     | M070         | 55      |
| D577         | 18 - 20       | D717         | 33      | E1515E       | 162     | M071         | 13 - 59 |
| D578         | 19            | D718         | 19      | E1520E       | 162     | M072         | 52      |
| D579         | 18            | D720         | 19      | E1520I       | 162     | M073         | 52      |
| D580         | 19            | D748         | 24      | E2020E       | 162     | M100         | 51      |
| D601         | 30 - 37       | D749         | 24      | E2020I       | 162     | M101         | 51      |

| Référence produit | Page    | Référence produit | Page          | Référence produit | Page      |
|-------------------|---------|-------------------|---------------|-------------------|-----------|
| M102              | 51      | MOA24             | 125           | S606              | 32        |
| M201              | 53      | MOAC              | 125           | S611              | 32        |
| M202              | 52      | MOAPLIN10         | 125           | S616              | 32        |
| M203              | 59      | MOAPLIN10M        | 125           | S702              | 32        |
| M204              | 52      | MOAPLINT          | 125           | S707              | 32        |
| M205              | 52      | MOAS              | 125           | S908              | 22        |
| M206              | 53      | MOD05             | 124 - 127     | S908A             | 22        |
| M207              | 53      | MOD06             | 124           | SD7042            | 76        |
| M208              | 59      | MOD23             | 122 - 124     | SD7043            | 80        |
| M209              | 59      | MOD24             | 124 -125 -126 | SD7044            | 80        |
| M210              | 59      | MOD25             | 124           | SD7045            | 84        |
| M211              | 51      | MODC              | 124           | SD7046            | 85        |
| M212              | 62      | MODS              | 124           | SD7047            | 76        |
| M213              | 53      | MOE45             | 124           | SD7052            | 80        |
| M250              | 63      | MOE60             | 124           | SD7054            | 76        |
| M251              | 63      | MOE90             | 124           | SD7055            | 79 - 84   |
| M252              | 63      | MOE120            | 124           | SD7056            | 76        |
| M253              | 63      | OPT140            | 144           | SD7057            | 80        |
| M254              | 54      | OPT141            | 144           | SD7500            | 79 - 81   |
| M255              | 61      | PL222             | 157           | SD7501            | 81        |
| M296              | 61      | PL223             | 157           | SD7502            | 81        |
| M297              | 54      | PL304             | 156           | SD7503            | 81        |
| M298              | 62      | PL314             | 156           | SD7504            | 81        |
| M299              | 54      | PL324F.BF         | 155 - 156     | SDC1              | 103       |
| M300              | 54      | PL621             | 158           | SDC2              | 103       |
| M301              | 49 - 54 | PL621F.BF         | 158           | SPOT              | 144       |
| M302              | 55      | PLAQ              | 162           | SV577             | 21        |
| M303              | 55      | PLAQ2             | 162           | SV748             | 21        |
| M304              | 55      | PLAQ3             | 162           | T.CAPITON165      | 130       |
| M306              | 62      | PLAQ5             | 162           | T.CAPITON180      | 130       |
| M390              | 60      | PLAQ6             | 162           | T.OCEAN160        | 130       |
| M400              | 61      | PLIN08            | 103           | T.OCEAN180        | 130       |
| M401              | 56      | PLIN08M           | 103           | T.SAHARA140       | 131       |
| M402              | 56      | PLIN10            | 103           | T.SAHARA160       | 131       |
| M403              | 56      | PLIN10A           | 103           | T.SAHARA180       | 131       |
| M404              | 60      | PLIN10M           | 103           | TAL12             | 106       |
| M405              | 57      | PLIN12            | 103           | TAL14             | 106       |
| M406              | 61      | PLIN12A           | 103           | TAL17             | 106       |
| M407              | 58      | PLIN15            | 103           | TALGM             | 106       |
| M420              | 69      | PLIN15A           | 103           | TALP              | 77        |
| M421              | 69      | PLIN20            | 103           | TALSP             | 106       |
| M422              | 69      | PLINT             | 103           | U1910             | 162       |
| M501              | 63      | PLINTA            | 103           | U1925             | 161 - 162 |
| M502              | 62      | R561              | 37            | U2410             | 162       |
| M05-242           | 127     | R601              | 32            | U2425             | 162       |
| M05-245           | 127     | R606              | 32            | U3210             | 162       |
| M05-545           | 127     | R611              | 32            | U3225             | 144 - 162 |
| M05-B115          | 127     | R616              | 32            | UF1005            | 163       |
| M05-ET398         | 127     | R702              | 32            | US0740            | 23        |
| M05-F0398         | 127     | R707              | 32            | US1040            | 23        |
| M05-H115          | 127     | S562              | 37            | VER56             | 144       |
| MOA23             | 125     | S601              | 32            | VER90             | 144       |



Gerne werden wir auch Ihren individuellen Wünschen gerecht. Schicken Sie uns eine Skizze Ihrer Idee, und wir erstellen Ihnen ein Angebot. Wünschen Sie eine ausführliche Beratung, rufen Sie an oder senden uns eine Mail.



T. 040 - 254 93 001  
F. 040 - 254 93 002



**Lager & Office**

Schwarzer Weg 5a  
22309 Hamburg  
Mo.-Fr. 09:00 - 15:00

**Ausstellungsraum**

Lübecker Str. 102  
22087 Hamburg  
Mo.-Fr. 14:00 - 17:30



[info@stuckhandel.de](mailto:info@stuckhandel.de)  
[www.stuckhandel.de](http://www.stuckhandel.de)